

RADIO

MAY, 1946

Design • Production • Operation

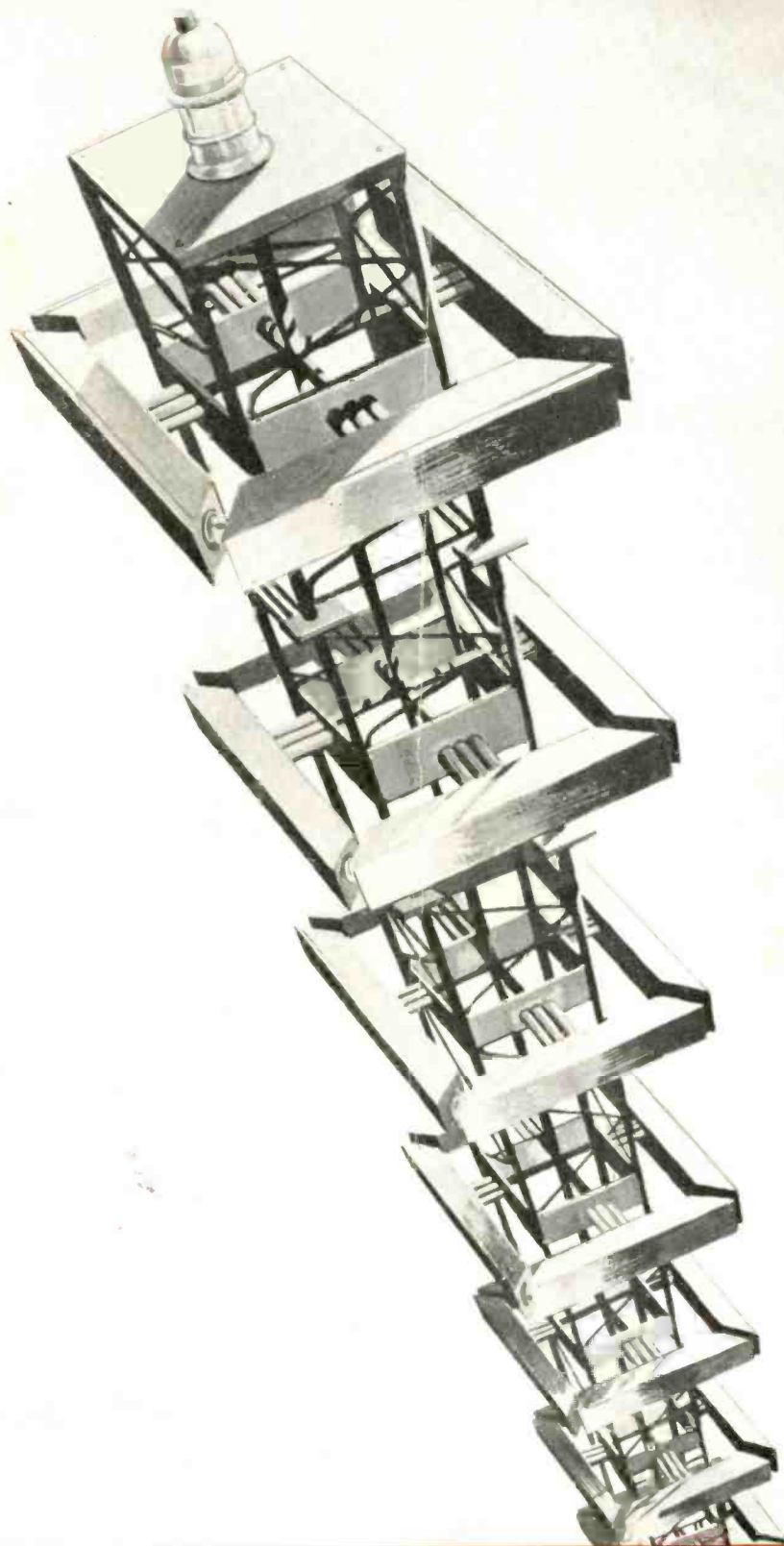

The Journal for Radio & Electronic Engineers

AMPHENOL

Covers the Spectrum

**WITH CABLES
AND CONNECTORS
FOR EVERY FREQUENCY**

Amphenol serves the electrical and electronic industries with the most complete line of cables, connectors, plugs and fittings for every application. No matter what the need—from high-current, low-voltage cables and connectors such as are used in power lines, to high-voltage, high-frequency components required in the upper regions of the spectrum—there is an Amphenol product for the job. Amphenol cables and connectors are used in Radar, F.M., Television, Standard Broadcast, electronic controls and equipment... and in numerous industrial applications.

Amphenol connectors are engineered and constructed so as to afford the absolute minimum of loss of power, potential or waveform even at the highest frequencies. These components reflect the greatest advancement in all phases of electrically correct design and mechanically correct manufacture. Amphenol makes the most complete line of cables, connectors, plugs and fittings for the most efficient transmission of power at all frequencies.



RADAR



TELEVISION



F.M.



RAILROAD



BROADCAST



INDUSTRIAL

AMERICAN PHENOLIC CORPORATION
CHICAGO 50, ILLINOIS

In Canada • Amphenol Limited • Toronto

COAXIAL CABLES AND CONNECTORS • INDUSTRIAL CONNECTORS, FITTINGS AND CONDUIT • ANTENNAS • RADIO COMPONENTS • PLASTICS FOR ELECTRONICS





RADIO

Published by RADIO MAGAZINES, INC.

John H. Polfs Editor
Sanford R. Cowan Publisher

MAY, 1946

Vol. 30, No. 5

CONTENTS

COVER

Square loop 8 Bay Antenna, with a power gain of 9, developed by Federal Telephone and Radio Corp. for f-m broadcasting. With this antenna a 180 kw effective radiated power can be obtained from a 20 kw transmitter — fully meeting the 150 kw power requirements recommended by FCC engineers for f-m stations. Even greater efficiency may be realized by stacking up to 16 of these loops whereupon a power gain of 20 is entirely feasible.

ARTICLES

Design Data and Characteristics of High-Frequency Cables, Part 1 —Karl Zimmermann	13
<i>New developments and useful formulae are presented</i>	
Use of Microwaves for Instrument Landing, Part 3—Donald F. Folland	16
<i>Design of successful apparatus for aircraft is discussed</i>	
Inductively Tuned Loop Circuits, Part 2—W. J. Polydoroff	20
<i>The inventor of permeability tuning concludes the presentation of his latest research work on this subject</i>	
Police Radio Equipment	23
Radio Design Worksheet No. 48—Reactive Feedback Factors	24
London Radiolocation Convention—Oliver Perry Ferrell	26
<i>A report on the Convention with summaries of papers presented</i>	

MISCELLANEOUS

Transients	4
TECHNICAL	6
Graphite Anode Tubes with Isolated Getter Trap	6
Broadcast Band-Spread	6
Triode-Connected Tubes	6
Metal-to-Glass Seals	8
Broadband Antenna	10
Miniature Thyatron	10
New Products	30
This Month	34
Book Reviews	45
Advertising Index	48

John H. Potts President-Editor
Sanford R. Cowan Sec'y-Treas.—Adv. Mgr.
Robert G. Middleton Associate Editor
Evelyn A. Eisenberg Assistant Editor
Harry N. Reizes Adv. Sales
J. J. Brookman Adv. Sales
David Saltman Adv. Prod. Mgr.
Miriam Birnbaum Circl. Manager

MID-WEST OFFICE

Harold J. Sugarman, Manager
82 West Washington St., Chicago 2, Ill.
ANDover 1395

PACIFIC COAST REPRESENTATIVE

H. W. Dickow
1387 40th Ave., San Francisco 22, Calif.

GREAT BRITAIN REPRESENTATIVE

Radio Society of Great Britain,
New Ruskin House, Little Russell St.,
London, W.C. 1, England

RADIO Magazine (title registered U. S. Pat. Off.) is published monthly at Boston Post Road, Orange, Connecticut, by Radio Magazines, Inc. Executive and Editorial Offices at 342 Madison Avenue, New York 17, N. Y. Subscription rates—United States, U. S. Possessions, & Canada, \$3.00 for 1 year; \$5.00 for 2 years, elsewhere \$4.00 per year; Single copies 35¢. Printed in U.S.A. All rights reserved, entire contents Copyright 1946 by Radio Magazines, Inc. Entered as Second Class Matter May 10, 1946 at the Post Office at Orange, Conn., under the Act of March 3, 1879.

NOW! FM

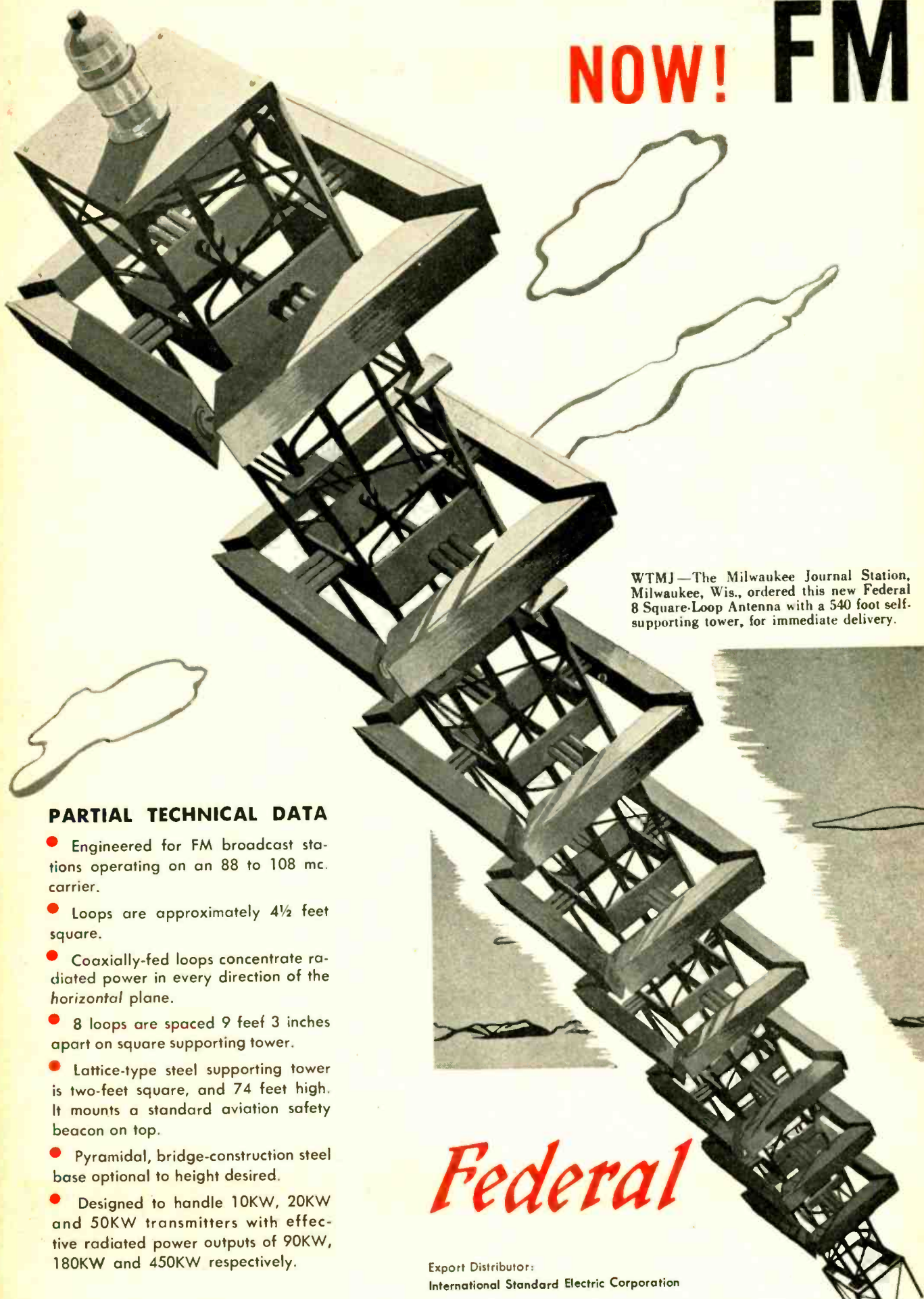

WTMJ—The Milwaukee Journal Station, Milwaukee, Wis., ordered this new Federal 8 Square-Loop Antenna with a 540 foot self-supporting tower, for immediate delivery.

PARTIAL TECHNICAL DATA

- Engineered for FM broadcast stations operating on an 88 to 108 mc. carrier.
- Loops are approximately 4½ feet square.
- Coaxially-fed loops concentrate radiated power in every direction of the horizontal plane.
- 8 loops are spaced 9 feet 3 inches apart on square supporting tower.
- Lattice-type steel supporting tower is two-feet square, and 74 feet high. It mounts a standard aviation safety beacon on top.
- Pyramidal, bridge-construction steel base optional to height desired.
- Designed to handle 10KW, 20KW and 50KW transmitters with effective radiated power outputs of 90KW, 180KW and 450KW respectively.

Federal

Export Distributor:
International Standard Electric Corporation

ANTENNA WITH NOMINAL POWER GAIN OF 9!

FEDERAL'S 8 SQUARE-LOOP ANTENNA PROVIDES 90KW EFFECTIVE POWER OUTPUT WITH A 10KW TRANSMITTER...

180KW WITH A 20KW TRANSMITTER... 450KW WITH A 50KW TRANSMITTER!

HERE IS STILL ANOTHER EXAMPLE of Federal's leadership in the entire field of FM... an 8-loop antenna with the highest power gain ever available in the FM broadcast service.

It radiates horizontally polarized waves so highly directive that very little energy is lost to useless ground or sky wave. Thus, with a power gain of 9, you can now get an effective power output of 90KW with a 10KW transmitter; 180KW with a 20KW transmitter and 450KW with a 50KW transmitter! This not only means a great saving on the cost of original equipment, but important economies of operation as well.

Be prepared for future FCC action increasing the effective radiated power!

One antenna is built for use over the entire FM range...

88 to 108 megacycles. Only one predetermined stub adjustment per loop changes it for any frequency in this band. Also, antenna array may be fed in two sections with separate coaxial lines to allow for emergency auxiliary operation.

Structurally, the tower is designed not to disturb the circular pattern of the antenna's radiation... is supported on a rugged, pyramidal base. The entire unit withstands high wind velocities and heavy icing loads.

Coming at a time when the FCC has given the green light to FM station construction, this remarkable new antenna is another contribution to the advancement of FM transmission... part of the "completely packaged service" which Federal now makes available. A Federal engineer will be glad to give you full details.

RADIATION PATTERN OF FEDERAL FM ANTENNA
Linear array—8 loops vertically stacked.

Shown at right is a square loop antenna in operation at the Federal laboratories. Design is similar to the 8 square-loop antenna.

Telephone and Radio Corporation

Newark 1, New Jersey



Transients

RADIO PRODUCTION

BESET with strikes, labor and material shortages, and OPA pricing difficulties, radio manufacturers have been through a trying time during the first quarter of this year. It is not surprising, therefore, that receiver production is still far below schedule. Of the total of one million sets produced for domestic use during March, 87 per cent were table models, 9 per cent were auto radios and but 4 per cent were consoles, reflecting the shortage of cabinets due to the lumber situation. The Westinghouse strike, now in its fourth month, has created a severe shortage of tubes because 95 per cent of the tube bases used by the industry are produced by this company. Depleted supplies of copper hamper production of transformers and cables, and postwar lassitude makes it difficult to attract production workers at wages which keep costs within bounds. And, over the entire picture, there is the problem of getting a selling price set by OPA which is adequate to permit a reasonable profit.

Despite these difficulties, many manufacturers are going ahead with production plans and expansion programs with a degree of resourcefulness and confidence which others would do well to follow. The Hallcrafters Company in Chicago is erecting a new 300,000 square-foot factory for the production of amateur apparatus, in addition to their other factories. General Electric has exhibited new plastic-cased three-way portables and an ambitious production schedule to fill piled-up orders has been announced. Other manufacturers are showing similar initiative.

Because receiver manufacturing is essentially an assembly proposition a shortage of a single component holds up production of the entire instrument. For this reason there is need for closer cooperation among component manufacturers that has previously existed lest all suffer for the misfortunes of one. The public has more money to spend than ever before, but if mass production of receivers does not get going to the fullest extent in the near future, this purchasing power will be diverted to other goods which are obtainable.

LEGAL SNAGS IN MOBILE RADIO OPERATION

IN many towns and cities local ordinances prohibit unauthorized use by individuals of portable and mobile radio sets capable of receiving police radio signals. These ordinances are often so loosely worded that a strict interpretation would prohibit the use of practically all auto radios. While obviously drawn for the purpose of protecting the public against criminals, enforcement leads to annoyance of law-abiding citizens, generally licensed amateurs with mobile rigs, whose apparatus look impressive to the police.

Now that two-way radio communication apparatus is being installed in cabs and other conveyances, it is particularly important that these laws be modified or wiped off the books. They may prove a hindrance to widespread use of such equipment in these new services, and in any event can no longer serve the purpose for which they were intended. Most certainly the practice of demanding a license fee, adopted by some communities, should be immediately prohibited. This situation has existed for some time and merits consideration by the FCC. Perhaps a test case should be carried through the courts to clarify the status of such ordinances.

GOVERNMENT SURPLUS APPARATUS

DUMPING of war surplus radio equipment by the government has brought into the retailing field many organizations not properly manned to handle such apparatus. Stores which previously sold only general merchandise are now retailing radio transmitters designed for operation on frequencies not open even to licensed amateurs. Too often sales are made to parties who are totally ignorant of the legal barriers to operating a transmitter, not to mention the technical qualifications required. The situation has become so serious that the FCC has issued a statement calling attention to the laws governing transmitter operation. It would be better, however, to see that such apparatus is distributed only through such outlets as are technically competent to give proper information to prospective purchasers.

—J. H. P.



...GET BACK ON THE AIR

★ SAVE CONSTRUCTION HOURS
★ BE SURE AS YOU BUILD

The Simpson Model 240 was introduced in 1939. In the two short years before "Hams" went off the air, this remarkable general service instrument built itself such a reputation that the demand for it has never ceased. During the war it was supplied to the Services in limited quantities. It has undergone steady improvement as the result of test and research. Now we can offer it to you again, a vastly better instrument than before—and it was always a sensational instrument.

Completely self-contained, needing no external multipliers, with a sensitivity of 1000 ohms per volt and a maximum voltage of 3000 volts A.C. or D.C., it has all the variety of useful ranges needed to do an all-around job for you.

The 3-inch meter has a scale over $\frac{1}{3}$ greater than before, offers greater accu-

racy in reading. The whole chassis is encased in heavy molded bakelite. All components and the sub-panel are mounted directly on the bakelite panel for easy servicing and greater sturdiness. All figures are engraved and filled with white enamel for greater legibility and wearing qualities.

Shock-proof, it has the famous Simpson movement with bridge-type construction and soft iron pole pieces, resistors in matched pairs to provide greatest possible accuracy for all ranges. It is furnished with test leads whose wire covering is capable of withstanding 3000 volts. Alligator clips have safety rubber guards.

Here is the instrument that will get you on the air and keep you there, helping you to build soundly and to trouble-shoot speedily and surely.

RANGES		
VOLTS A. C.	VOLTS D. C.	MILLIAMPERES D. C.
0-15	0-15	0-15
0-150	0-75	0-75
0-750	0-300	0-300
0-3,000	0-750	0-750
	0-3,000	

Ohms: 0-3,000 (center scale 30)
0-300,000 (center scale 3,000)

THE NEW SIMPSON MODEL 240—THE "HAMMETER"

—1946 version of the first self-contained pocket portable instrument built expressly to check high voltage and all component parts of transmitters and receivers.

Price, complete with test leads.....\$26.50

Ask Your Jobber

SIMPSON ELECTRIC CO.
5200-5218 W. Kinzie St., Chicago 44

Simpson

INSTRUMENTS THAT STAY ACCURATE



TECHNICANA

GRAPHITE ANODE TUBES WITH ISOLATED GETTER TRAP

★ Graphite anode tubes have been limited to relatively few types in past years, due to manufacturing difficulties of degassing an anode of such great mass, and consequent high cost of manufacture. Heavy getter deposits upon the tube bulb have also constituted a barrier to the black-body heat-dissipating qualities of graphite.

Crystal-clear glass bulbs have been realized through the agency of the isolated getter trap, developed by United Electronics Co. engineers. It is reported that the development makes possible graphite-anode tubes capable of dissipating large quantities of heat, and improved operation on very high frequencies.

The radiating emissivity of graphite is 94% of black body. Its thermal conductivity is 1.92, and it is noted that high thermal conductivity permits rapid and uniform distribution of heat which avoids hot spots and consequent warping or fusing of tube elements. At average tube ratings, the normal operating temperature of graphite is 500° to 600° C. Graphite itself has no melting point, being infusible.

High-frequency operation of tubes requires constant inter-element spacings to achieve uniformity of tube and circuit response. It is stated that graphite anodes are accordingly well adapted to high-frequency operation, graphite being run at comparatively low temperature and with little color. The independent gettering agent is designed to function at all temperatures.

It is reported that graphite anode tubes

with the isolated getter trap have an initial gas content usually under one microampere, and that the tube becomes harder over several hundred hours of operation. Filament emission likewise improves.

Tabulation of readings as reported by engineers of United Electronics Co. for life tests conducted on the V-70-D tube with 612 watts continuous input at 30 mc is shown in Table I. Emission improvement is shown as the emission voltage reading is reduced; that is, the lower the emission voltage reading, the better the emission.

These life tests represent operation in excess of ratings, the V-70-D being rated for 300 watts maximum input ICAS, and the tests being made at 306 watts continuous input.

United Electronics engineers predict revolutionary new conceptions of graphite-anode applications and revised viewpoints among tube users who in the past have not given much thought to the use of graphite-anode tubes for operation at frequencies above 100 mc.

BROADCAST BAND-SPREAD

★ Various factors in broadcast receiver design which are of particular importance when short-wave band-spreading is used are discussed by D. H. Hughes in the *Journal of the Institution of Electrical Engineers*, Part III, for March 1946, in an article entitled *The Design of Band-Spread Circuits for Broadcast Receivers*.

The practical aspects of the problem are stressed throughout, with considerable attention to preselector and oscillator circuits. The basic circuit for band-

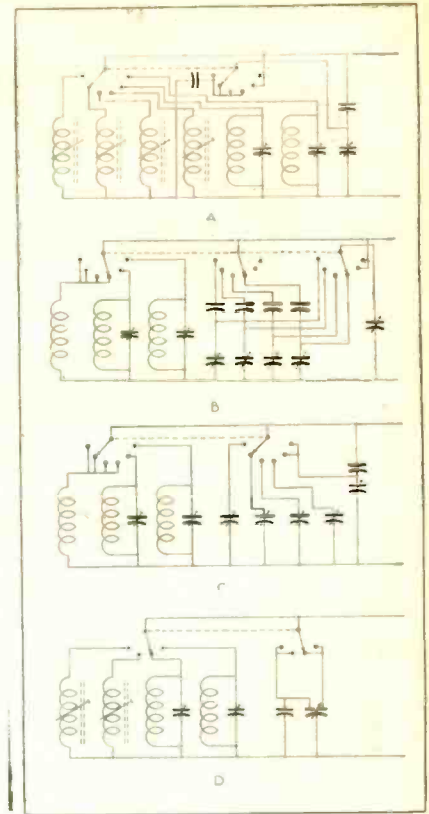

Figure 1

spread tuning by variable capacitance is analyzed, and formulas are developed for calculating the elements of the capacitance network. From these, graphical methods of solution are derived and illustrated.

Four recommended circuits for band-spreading are illustrated in *Fig. 1*: (a) A separate coil is used for each band, with one pair of fixed condensers common to all spread bands. (b) A separate pair of fixed condensers for each band, with one coil common to all spread bands. (c) One fixed condenser changed for each band, the other fixed condenser and the coil being common to all spread bands. (d) A special type of gang condenser, with a parallel fixed condenser, and a separate coil for each band.

The use of temperature-compensating condensers and various methods of circuit trimming are also discussed. It is shown that there is considerable divergence in design to suit the various price ranges of receivers, and although the best methods, as usual, cost more, simpler methods can be made reasonably good by careful design.

TRIODE-CONNECTED TUBES

★ Without entering into the controversy of triodes vs. tetrodes and pentodes, C. C. McCallum notes in *Electronic Engineering* for March 1946 that when efficiency is not of prime importance, triodes offer advantages to quality-conscious enthusiasts. Cathode-follower output circuits, as shown in *Fig. 2* are beginning to find favor, states

[Continued on page 8]

TABLE I

Life Test Record, Type V-70-D, Random Production Tubes										
Dynamic Conditions of Continuous Operation										
30 mc, push-pull oscillator; $E_p = 1750$ vdc; $I_p = 175$ ma per tube;										
$I_o = 25$ ma per tube; input per tube = 306 watts; dissipation per										
tube = 80 watts; useful power output per tube = 226 watts;										
efficiency = 74%										
	Test Readings After			Total Hours Indicated						
(First sample)	0	16	32	77	134	179	242	338	385	403
	hrs	hrs	hrs	hrs	hrs	hrs	hrs	hrs	hrs	hrs
Emission volts	6.7	6.7	6.6	6.6	6.5	6.5	6.5	6.6	6.6	6.6
Gas current μ a	1.4	1.1	0.6	0.6	0.3	0.3	0.4	0.4	0.4	0.4
(Second sample)										
Emission volts	6.7	6.7	6.7	6.7	6.5	6.5	6.6	6.6	6.6	6.6
Gas current μ a	0.5	0.6	0.6	0.6	0.5	0.5	0.6	0.4	0.4	0.4

Motorola Radio LEADS AGAIN

with **152-162** MC. 2-WAY RADIOTELEPHONE EQUIPMENT

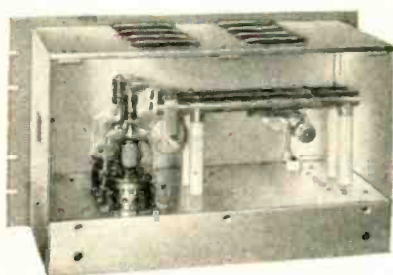

Push-Pull Final Amplifier



Motorola RADAR RESEARCH Makes This Advance Possible!

Motorola's extensive RADAR development and productive activity is reflected in the new line of 152-162 mc. equipment. The use of cavities, lines and microwave techniques provide exceptional performance and trouble-free service in the new bands.

The new 152-162 mc. equipment has been field-tested and proved before being released. Recently, field tests were conducted at the Motorola factory before a group of APCO members. The tests included comparison of 250-watts 162 mc. and 30-40 mc. equipment using a 150-ft. tower for antenna support. The Central Station power was reduced to 15 watts. Two cars using 15-watt transmitters were cruised over a radius of 20 miles including areas like the loop, lower level of Wacker Drive and Lake Shore Drive with tall buildings between the cars and Central Station, in addition to the normal territory encountered in a large city. Solid 2-way coverage with marvelous fidelity and very high signal-to-noise ratio was reported. Comparison with 30-40 mc. over the same area showed marked superiority of 162 mc.

Motorola proudly announces its 152-162 mc. equipment with the Model FSTRU-250-BR 250-watt Central Station Transmitter-Receiver unit.

For the past five years over 80% of all police 2-way radio installations have been Motorola! Motorola Radiotelephone systems are widely used by leading railroads, fire departments, power companies, gas and oil pipe lines, taxi companies, cross-country bus and truck lines and municipal transit companies.

For information showing how Motorola Radiotelephone can solve your specific communications problems—write today!

GALVIN

MFG. CORPORATION • CHICAGO 51
COMMUNICATIONS AND ELECTRONICS DIVISION

F-M & A-M HOME RADIO • AUTO RADIO • PHONOGRAPHS • TELEVISION • "HANDIE TALKIES" • POLICE RADIO • AIRCRAFT RADIO

RADIO

★ MAY, 1946

7

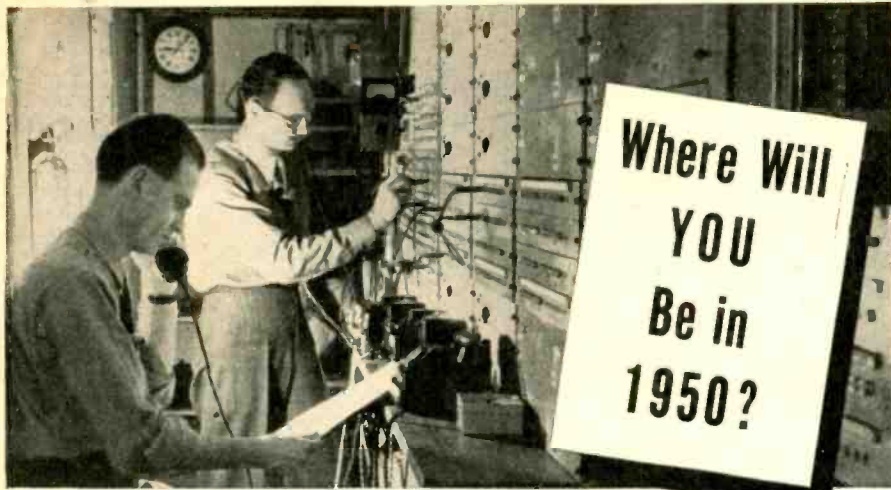

ENJOY SECURITY AND GOOD PAY! PREPARE NOW WITH CREI TECHNICAL HOME STUDY TRAINING. STEP AHEAD OF COMPETITION INTO A GOOD RADIO JOB! — CREI Offers You a Proved Program of Self-Improvement to Keep Pace with Modern U. H. F. Advancements and Get That Radio Engineering Job You Want

Yes, there are GOOD JOBS . . . for GOOD men! The easy jobs are gone and once again knowledge and ability are the requirements to HOLD good jobs — to SECURE better ones. Employers once again can afford to be "choosy" . . . to select the best man for the best job. In the face of this show-down situation — where do YOU stand?

CREI home study training in Practical Radio-Electronics Engineering can equip you to meet the requirements to hold your job — or advance to a better one. CREI graduates are recognized throughout the Radio-Electronics industry. Your CREI diploma is the best recommendation for a better job. By adding CREI training to your present radio experience you can safeguard your future and keep pace with such new developments as U. H. F. Circuits, Cavity Resonators, Pulse Generators, Wave Guides, Klystrons, Magnetrons and other tubes. Are you equipped to handle them? CREI is equipped to help you, by providing the know-how and ability that is required.

In our proved method of instruction, you learn not only how but why! Easy-to-read-and-understand lessons are provided well in advance, and each student has the benefit of individual guidance and supervision from a trained instructor. This is the basis of the CREI method of training which many thousand professional radiomen have completed during the past 19 years. CREI courses were used during the war to train thousands of Army and Naval radio technicians for the U. S. Signal Corps, U. S. Navy and U. S. Coast Guard.

It's up to you now to decide your course. What you do today will be the answer to where you will be in 1950 and the years after. It costs you nothing to read the interesting facts . . . to learn how CREI can help you enjoy the security you want . . . the better-paying job that can be yours. Write for particulars now. (CREI training for Veterans is approved under the "G.I." Bill.)

Capitol Radio Engineering Institute

E. H. Rietzke, President

Dept. RA-5, 16th and Park Road, N. W., Washington 10, D. C.

Branch Offices:

New York (7): 170 Broadway
San Diego (1): 316 C Street

Chicago (2): 30 N. LaSalle Street
San Francisco (2): 760 Market Street

Member: NATIONAL HOME STUDY COUNCIL, NATIONAL COUNCIL OF TECHNICAL SCHOOLS

Just Off the Press



WRITE FOR FREE 36-PAGE BOOKLET

"Your Opportunity in the New World of Electronics"

Tells how CREI courses can be adapted to your particular needs.

If you have had professional or amateur radio experience and want to make more money, let us prove to you we have something you need to qualify for a better radio job. To help us intelligently answer your inquiry — PLEASE STATE BRIEFLY YOUR BACKGROUND OF EXPERIENCE, EDUCATION AND PRESENT POSITION.

TECHNICANA

[from page 6]

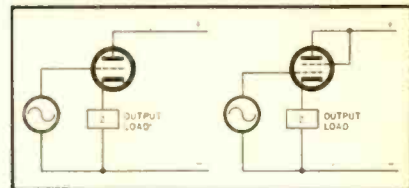

Figure 2

Mr. McCallum, because of the damping imposed on the speaker.

A chart, reproduced in Fig. 2 for American tube types, was prepared by this author to indicate the power output to be expected from a representative range of triodes, pentodes, and beam tetrodes, the latter two types being connected as triodes. Tube types are: A, 50; B, 45; C, 2A3; D, 6Y6; E, 6L6; F, 6V6; G, 6F6; H, 2A5; I, 6G6; J, 6X6.

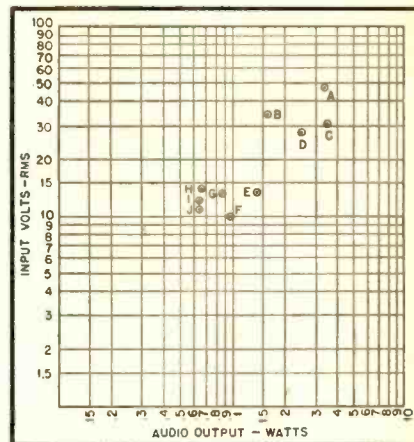

Figure 3

To give the chart greater value, the input swing necessary to obtain the stated power output can also be noted from the scales. The figures have been given with due regard to maximum dissipation requirements, restriction of second harmonic distortion to a maximum of 5% of the fundamental, and utilization of optimum load resistance.

METAL-TO-GLASS SEALS

★ Work on British-made iron-nickel-cobalt alloys of the "Kovar" type for sealing to borosilicate glasses is summarized in an article entitled "Iron-Nickel-Cobalt Alloys for Sealing to Glass" by G. D. Redston, in the *Journal of Scientific Instruments* for March 1946.

Several measured expansion curves are given for these alloys, and following a discussion of the effect of composition on expansion properties, a specification is suggested based upon nominal composition and expansion properties. Finally, stresses in sandwich seals of the specified alloy and a suitable borosilicate glass are discussed, using measured stress-temperature curves. It is shown

[Continued on page 10]

YOU CAN SIT BACK AND RELAX...

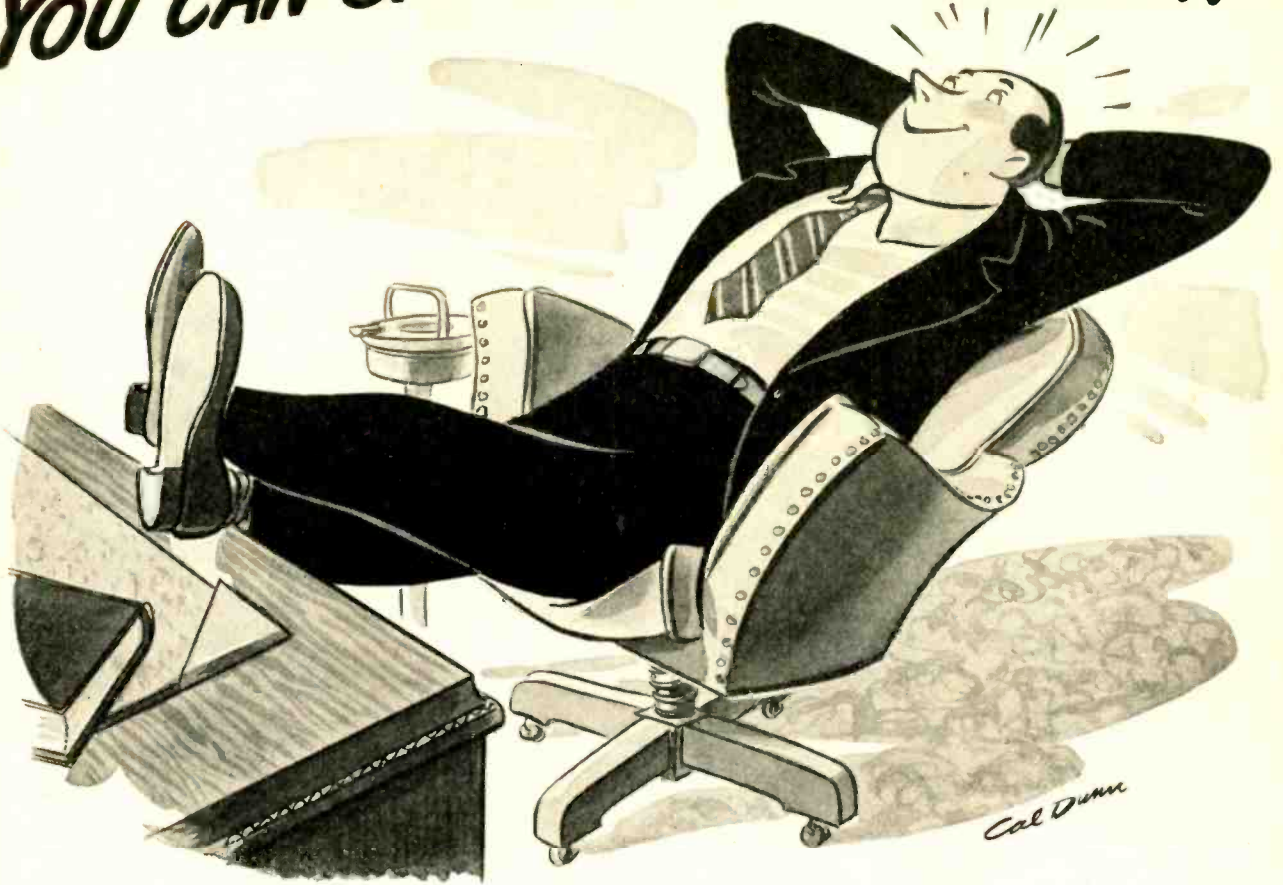

... when Adlake Relays are on the job!

YES... with an Adlake Relay handling the control job, you can sit back and relax. Because Adlake Plunger-type Mercury Relays are dependable and tamper-proof!

Control is fully automatic. No servicing or periodic cleaning needed.

Contacts hermetically sealed in metal or glass cylinder— not affected by dust, moisture, or temperature!

Mercury-to-mercury contact—no burning, pitting, or sticking. Positive, noiseless, chatterless, and arcless!

Armored against impact and shock—use for either stationary or moving equipment!

There's an Adlake Plunger-type Mercury Relay for every job! Send today for interesting, free bulletin. All types described in detail. No obligation.

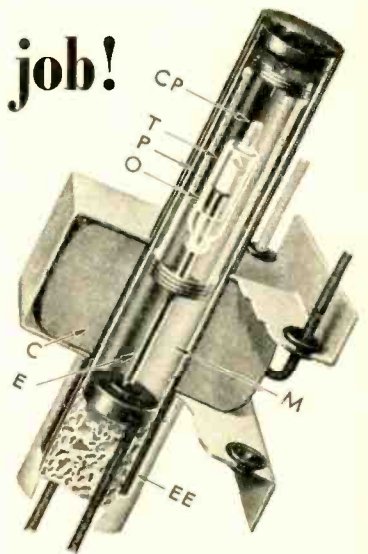

HOW ADLAKE RELAYS WORK

ENERGIZED—Coil C pulls plunger P down into mercury M. Mercury thus displaced enters thimble T through orifice O. Inert gas in thimble gradually escapes through ceramic plug CP.

Mercury now fills thimble T, is completely leveled off and mercury-to-mercury contact established between electrodes E and EE. Degree of porosity of ceramic plug CP determines time delay.



THE ADAMS & WESTLAKE COMPANY

ESTABLISHED IN 1857

ELKHART, INDIANA

NEW YORK • CHICAGO

Manufacturers of Adlake Hermetically Sealed Mercury Relays for Timing, Load and Control Circuits

RADIO ★ MAY, 1946

TECHNICANA

[from page 8]



Just a few of the thousands of Radio Parts manufactured by INSULINE

You will find the best in radio parts, stampings, chassis, cabinets, and auto-radio antennas in the new I.C.A. catalogs. Be sure to send for your copies as soon as possible.

Address Dept. C-2, Insuline Corporation of America, Insuline Building, Long Island City, N.Y.

that seals with very low stresses at all temperatures can be made.

A suggested composition for iron-nickel-cobalt alloys is: 29% nickel ($\pm 0.5\%$), 17% cobalt, 0.3% manganese, 0.15 silicon $\pm 0.05\%$ carbon, $\pm 0.01\%$ phosphorus, 0.01% sulfur, with 46% $\pm 0.5\%$ of nickel plus cobalt.

The specified expansion properties of the alloy may be based on differential at 25° C., the curve should pass through a point 3×10^{-4} ($\pm 1 \times 10^{-4}$) above the molybdenum line.

Suitable glasses can be made to match the above alloys. The stresses in the glass-metal combination are low at all temperatures, and the stress in a sandwich seal can be arranged to be compressive at all temperatures, if desired.

BROADBAND ANTENNA

★ A broadband 160-megacycle ground plane antenna has been designed to meet the rigorous requirements of railroad service for two-way communication between train and fixed station and end to end service. The antenna is manufactured by American Phenolic Corporation.

The antenna utilizes the metal top of the car for its ground plane. It is fed by ar-

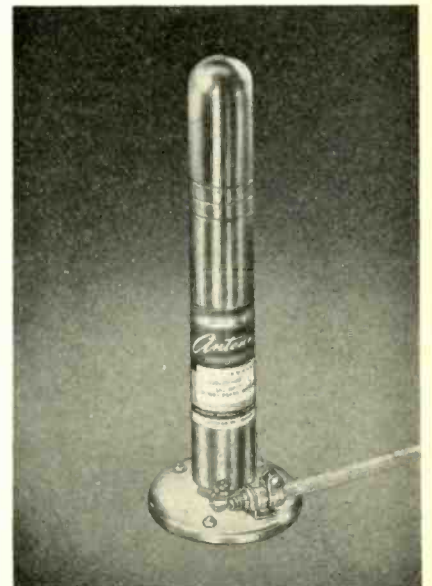

mored 52 ohm coaxial transmission line. The radiation pattern in the horizontal plane is circular in shape and the voltage standing wave ratio is less than 1.5 to 1 from 152 to 162 mc. The gain of the antenna is 0.5 decibels less than a dipole.

The assembly is constructed of steel, heavily cadmium plated and have an overall height of 14½ inches. It is secured to the car by three ¼ inch - 20 bolts.

MINIATURE THYRATRON

★ A miniature thyatron measuring only 2½" overall and mounted in a T-5½ bulb, suitable for many electronic control applications where equipment must be com-

[Continued on page 46]



insuline

CORPORATION OF AMERICA

INSULINE BUILDING • LONG ISLAND CITY, N. Y.

More than a quarter-century of Quality production.





THE COUNTERSIGN OF DEPENDABILITY IN ANY ELECTRONIC EQUIPMENT

NEW ELEMENTS IN THIS EIMAC TRIODE ADD MANY EXTRA HOURS PERFORMANCE

- NEW** NON-EMITTING GRID!
- NEW** LOW-TEMPERATURE PLATE!
- NEW** FILAMENT STRUCTURE!

Physically the new Eimac 3-250A triode is interchangeable with the old Eimac 250T. The new elements result in better performance and even longer life in a tube that has long been famous for its long life and stamina. This new tube is available in both low mu (3-250A2) and high mu (3-250A4) tube versions.

Its outstanding performance characteristics are exemplified by its low driving power requirements. For example, in Class C telegraphy, with 3000 plate volts on a single tube, the Eimac 3-250A2 (low mu) will deliver 750 watts output with only 29 watts (approx.) of driving power. (See chart.)

You can depend upon Eimac year in and year out for leadership in vacuum tube developments.* That's one reason why Eimac tubes are today, and have been for years, first choice of leading electronic engineers throughout the world.

*Ask your dealer to give you a copy of "Eimac Electronic Products" just off the press. Or write direct.

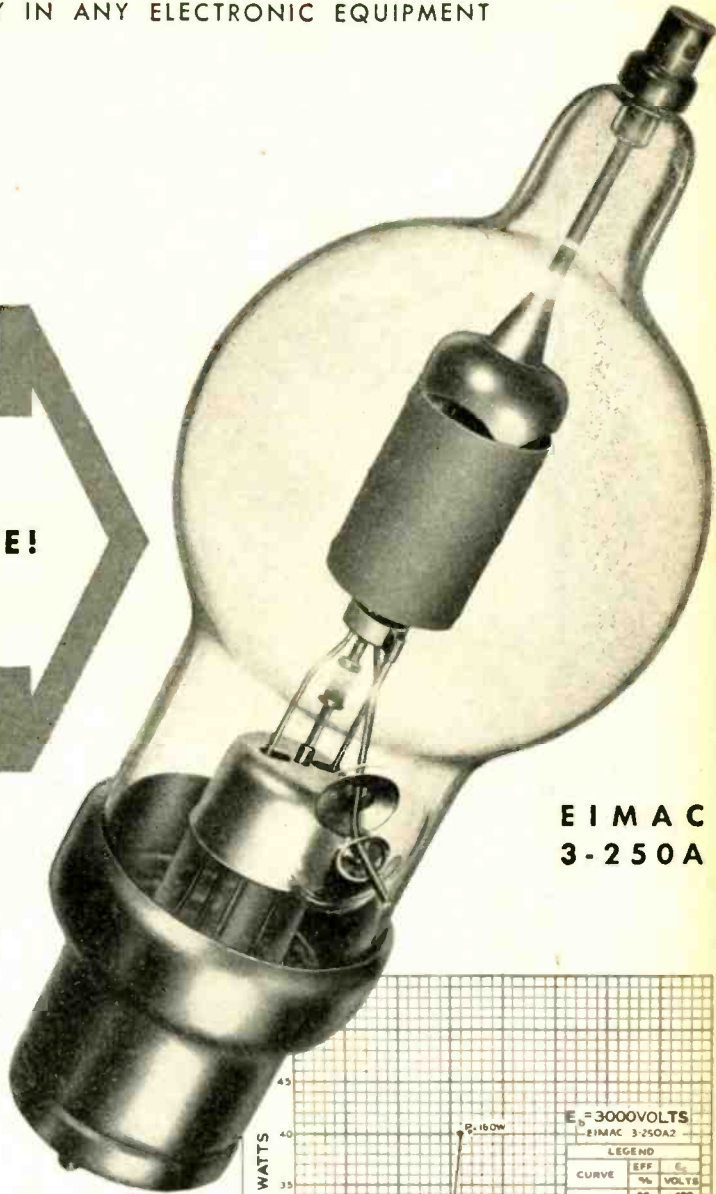

**EIMAC
3-250A**

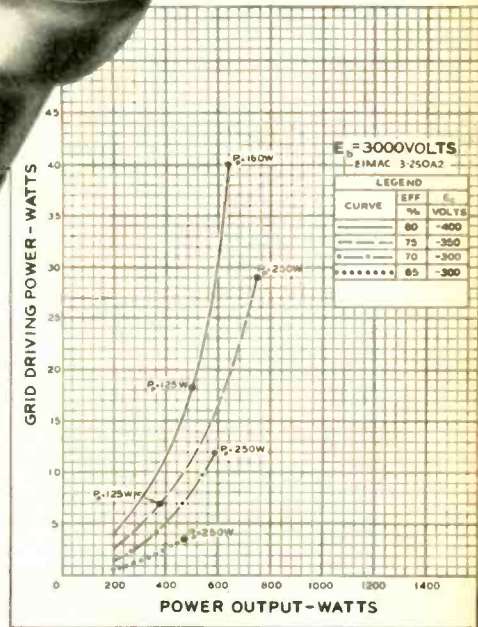

Follow the leaders to



EITEL-McCULLOUGH, INC., 1211-G San Mateo Ave., San Bruno, California

Plants located at: San Bruno, Calif. and Salt Lake City, Utah

Export Agents: Frazar and Hansen, 301 Clay St., San Francisco 11, California, U.S.A.

CALL IN AN EIMAC REPRESENTATIVE FOR INFORMATION

ROYAL J. HIGGINS (W9A10)... 600 South Michigan Avenue, Room 818, Chicago 5, Illinois. Phone: Harrison 5948.

ADOLPH SCHWARTZ (W2CN)... 220 Broadway, Room 2210, New York 7, New York. Phone: Cortland 7-0011.

V. O. JENSEN, General Sales Co., 2616 Second Avenue, Seattle 1, Washington. Phone: Elliott 6871.

HERB BECKER (W6QD)... 1406 So. Grand Avenue, Los Angeles 15, California. Phone: Richmond 6191.

M. B. PATTERSON (W5C1)... 1124 Irwin-Kessler Building, Dallas 1, Texas. Phone: Central 5764.

TIM COAKLEY (W1KQP)... 11 Beacon Street, Boston 8, Massachusetts. Phone: Capitol 0050.

ELECTRICAL CHARACTERISTICS

Filament: Thariated tungsten	3-250A2	3-250A4
Voltage	5.0 volts	5.0 volts
Current	10.5 amperes	10.5 amperes
Amplification Factor (Average)	14	37
Direct Interelectrode Capacitances (Average)		
Grid-Plate	3.1 uuf	2.9 uuf
Grid-Filament	3.7 uuf	5.0 uuf
Plate-Filament	0.7 uuf	0.7 uuf

THE IMC ENGINEER IS
On Your Staff-
BUT NOT ON YOUR PAYROLL

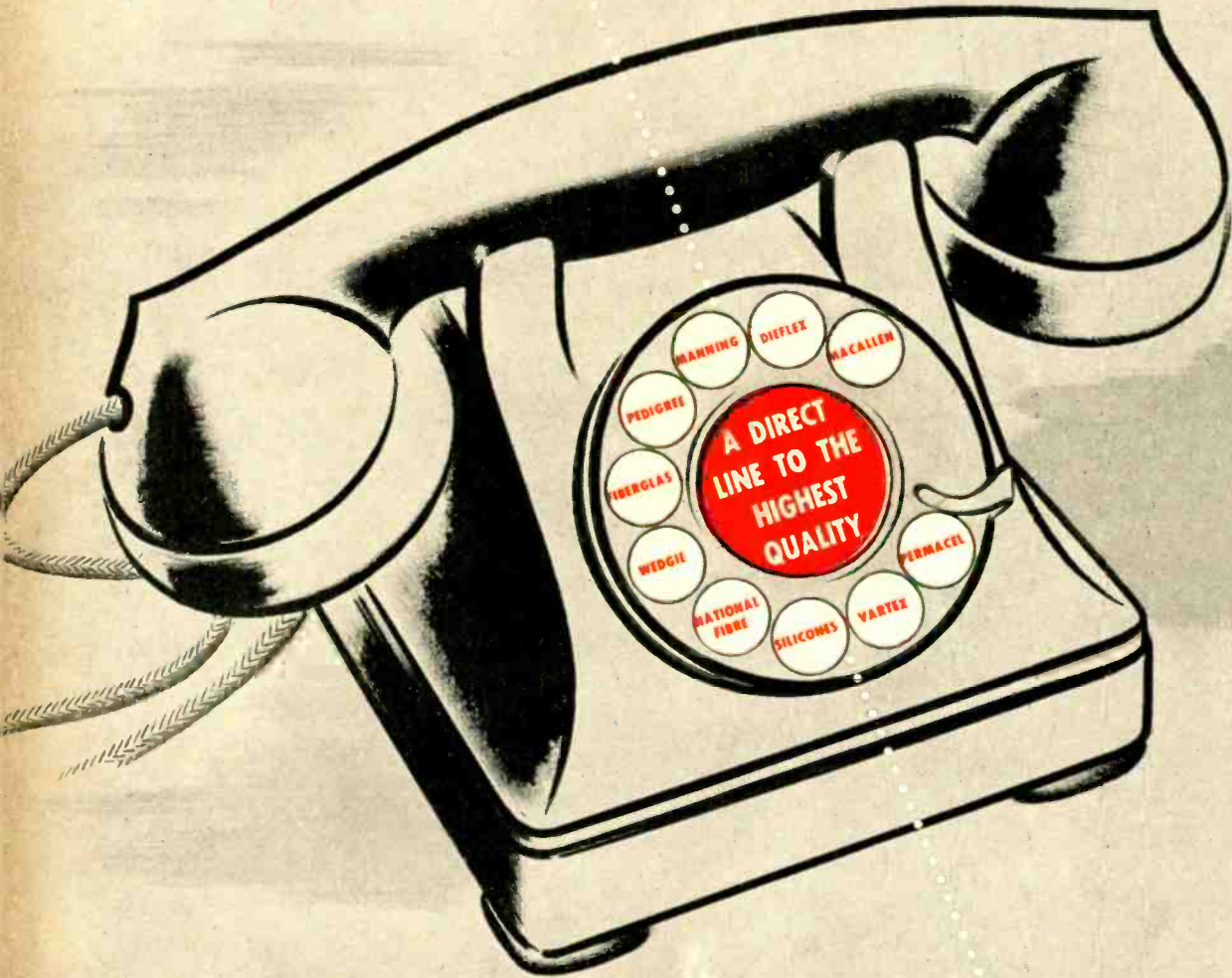

Call him when you need Insulation assistance

A quick summons brings the IMC engineer to your side to give expert consideration and advice on all your most intricate and stubborn electrical insulation problems. He will serve you well . . .

1. Assist in selection of best insulating materials for the specific job. (Note well-known nationally recognized products from which to make selections.)
2. Give instructions as to proper application.
3. Suggest ways to eliminate waste.
4. Speed up and increase your production.

He will welcome your call . . . any time. Phone or write to us or nearest branch office.

IMC PRODUCTS: Macallen Mica Products—Vartex Varnished Cloth and Tapes—Varslot Combination Slot Insulation—Varnished Silk and Paper—Fiberglas Electrical Insulation—Manning Insulating Papers and Pressboards—Dow Corning Silicones—Dieflex Varnished Tubings and Saturated Sleeveings of Cotton and Fiberglas—National Hard Fibre and Fishpaper—Phenolite Bakelite—Adhesive Tapes—Asbestos Woven Tapes and Sleeveings—Cotton Tapes, Webbing, and Sleeveings—Pedigree Insulating Varnishes—Wedgie Brand Wood Wedges.

Representatives in: **MILWAUKEE 2:** 312 East Wisconsin Avenue
DETROIT 2: 11341 Woodward Avenue **MINNEAPOLIS 3:** 1208 Harmon Place
PEORIA 5: 101 Heinz Court And other cities

INSULATION
MANUFACTURERS CORPORATION

★CHICAGO 6
565 W. Washington Blvd.

ELECTRICAL INSULATION

★CLEVELAND 14
1005 Leader Bldg.

DESIGN DATA AND CHARACTERISTICS OF HIGH-FREQUENCY CABLES

KARL ZIMMERMANN

Federal Telephone and Radio Corp.

New design factors and manufacturing methods to meet the rigid mechanical and electrical specifications required in modern applications of high-frequency cables are described.

PART 1

EXPANSION of the use of high frequencies for many electronic applications such as radar, television, FM, and instrument landing systems has posed an urgent need for highly engineered, precision cables. From the critical lengths of the conductors to the low power-factor of the dielectric, to the tough elastic jacket—all components of the cable must meet rigid specifications so that the final product can serve its purpose. Materialization of this cable required the combined skills of chemical, mechanical and electrical engineers to achieve the elastic, durable, electrically accurate and efficient cable of today.

The use of wavelengths of the order of centimeters introduced several unprecedented problems in transmission line design. From the electrical standpoint, the characteristic impedance became one of the most important properties of the cable, while the calculation of the attenuation and power rating necessitated a complete new approach. Mechanically, the extremely low tolerance under which these cables were produced demanded the development of highly specialized control machinery (electronic control is used at Federal), while the chemists devote much time toward synthesizing new dielectric compounds to insulate the conductors and new materials to jacket the cable.

The characteristic impedance, sometimes referred to as the natural, iterative, or surge impedance, is usually denoted by Z_0 and is expressed in ohms. In a low-loss h-f line of uniform dimensions and conductor spacing this impedance is a pure resistance and therefore is independent of frequency.

A transmission line can be considered to be an infinity of infinitesimals, each comprising lumped constants of resistance, inductance, capacitance, and leakage conductance, and its characteristic

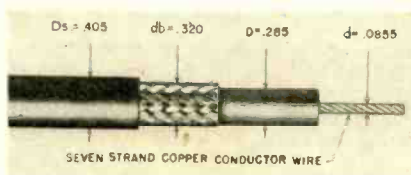

Fig. 1. Dimensions and construction of a typical coaxial cable.

impedance is calculated from the following relation

$$Z_0 = [(R+j\omega L)/(R+j\omega C)]^{1/2} \quad (1)^2$$

where

R = resistance in ohms per unit length
 L = inductance in henries per unit length
 C = capacitance in farads per unit length
 G = conductance in mhos per unit length

which reduces to

$$Z_0 = (L/C)^{1/2} \quad (2)$$

since R is very small compared to ωL and G is very small compared to ωC . And since

$$V = (k/LC)^{1/2} \quad (3)^2$$

where

V = the velocity of light
 k = the dielectric constant of the material separating the two conductors

we obtain

$$L = \frac{k}{V^2 C} \quad (4)$$

then equation (2) may also be written in the form

$$Z_0 = 1016k^{1/2}/C \quad (5)$$

where C = capacitance in $\mu\mu\text{f}$ per foot

Equations (2) and (5) are valid for any shape or form of the transmission line.

Coaxial Line

The most common type of high-frequency transmission line is the coaxial type (Fig. 1). For this type of line both inductance and capacitance are functions of the cable dimensions and

for a solid inner conductor follow the relation

$$L = 0.140 \log_{10} D/d \quad (6)$$

$$C = (7.36 k) / (\log_{10} D/d) \quad (7)$$

where

L = microhenries per foot
 D = outer diameter of dielectric
 d = diameter of inner conductor
 C = $\mu\mu\text{f}$ per foot
 k = dielectric constant

In the equation for inductance the internal inductance of the conductors is neglected since, at high frequencies, the current is confined to the outer surface of the inner conductor and the inner surface of the outer conductor.

Substituting (6) and (7) in (2) gives the well-known equation for Z_0 in terms of the diameters of the conductors and the dielectric constant of the insulating material.

$$Z_0 = (138 \log_{10} D/d) / k^{1/2} \quad (8)$$

It should be noted that this equation is true only for coaxials with a solid inner conductor using low-loss dielectrics.

However, particularly from a mechanical standpoint, this type of coaxial construction has limitations where a large range of capacity and characteristic impedance are desired. In the first place the size of the inner conductor that can be used is very limited. For if its diameter is too small the conductor does not have sufficient tensile strength to withstand the tensions used during the manufacturing process, while a large diameter wire is not flexible enough. Another limitation on this type of coaxial is the size of the overall outer diameter. Obviously the only way to obtain a high impedance or low capacity line is to increase the ratio of outer-to-inner diameter. But beyond a certain point this becomes impractical because the cable becomes too bulky, weighty, inflexible, and uses a prohibitive amount of comparatively expensive dielectric.

Stranded Inner Conductors

To increase the flexibility of the cable a seven-strand copper inner conductor is frequently employed. While this type of inner conductor materially improves the mechanical performance of the cable it also affects its electrical properties. Not only does it increase the attenuation of the cable, but it also affects its surge impedance.

This latter fact can readily be deduced upon examination of equation (2) or (5) because the interstices of the strands increase the capacity of the cable over that of an equivalent solid conductor line. While there are some theoretical formulas for determining the increase in capacity due to stranding, they are not generally known or utilized and an empirical formula, based on experimental data, is being used. This formula is only true for 7-strand conductors and is

$$C = (7.360 k) / (\log_{10} D/d) \quad (9)$$

where

$d' = 2.8 d_0$, d_0 being the diameter of one strand. This value is equivalent to 0.934 of the total diameter of the conductor.

Using this new value of C , the equation for the characteristic impedance of stranded inner conductor line can be expressed

$$Z_0 = (138 \log_{10} D/d) / K^{1/2} \quad (10)$$

The nomograph chart (Fig. 2) gives the characteristic impedance of polyethylene cables, eliminating the necessity of long calculations.

Low Capacitance Lines

As has previously been pointed out, there is a maximum practical surge impedance or minimum capacitance that the coaxial lines heretofore discussed can have. But in many applications it is highly desirable to produce lines above this limit and for that reason two different types of coaxials have been developed, one the low-capacitance air-spaced cable (Fig. 3) and the other the high-inductance spiral delay type (Fig. 4).

Here again we examine the basic equations for characteristic impedance, (2). Obviously Z_0 can be increased by either decreasing C or increasing L and that is precisely what has been attempted. The equation for C , using a solid inner conductor, has been given in equation (7), and the most logical way to reduce C would be to make k a minimum. This occurs when air is used as a part of the dielectric and this type of cable is called an air-spaced cable. Of course this presents some highly complicated mechanical problems particularly since it is very important to obtain absolute uniformity throughout the cable. The old system of using beads as periodic supporters does not meet this requirement and the solution to the problem seems to be the use of a spiral

of polyethylene. It should be remembered that manufacture of this type of cable is comparatively costly, and it only increases the characteristic impedance by a factor of approximately 0.5. This type of line is mainly produced when a low-capacity cable is needed.

High Impedance and Delay Lines

When an impedance of the order of 1000 ohms is desired the solution is to increase L . This is done in the spiral delay cable by making the inner conductor an insulated core around which a spiral of insulated wire is wrapped. The inductance of a single layer coil of this type is then

$$L = 3.06 \times 10^{-2} \pi^2 n^2 a^2 \text{ microhenries per foot} \quad (11)$$

where

n = number of coil turns per inch

a = diameter of coil between wire centers, in inches

The characteristic impedance then becomes

$$Z_0 = [64.5 \pi n a (\log_{10} D/d)^{1/2} / K^{1/2}] \quad (12)$$

This type of line as a considerable time delay due to the high inductance of the

spiral center conductor, which may be advantageous, and can be shown to be equal to

$$T = (LC)^{1/2} = \frac{4.76 \cdot 10^{-4} \pi n a (k)^{1/2}}{(\log_{10} D/d)^{1/2}} \text{ microseconds/foot} \quad (13)$$

Balanced Lines

There are a number of applications where a twin-conductor or balanced-line type of cable is used instead of a coaxial type. In general, whenever a source of balanced power, neither side of which is grounded, must be transmitted by wire, a twin or duplex conductor cable will be necessary. This type of cable varies in construction from the highly expensive dual coaxial line to the relatively inexpensive antenna lead-in (Figs. 5, 6, 7).

The mathematics involved in calculating the inductance and capacitance of twin conductor cables are far more complicated than those used to determine the coaxial type and there are no exact solutions available for any but the simplest type of configurations. This is due

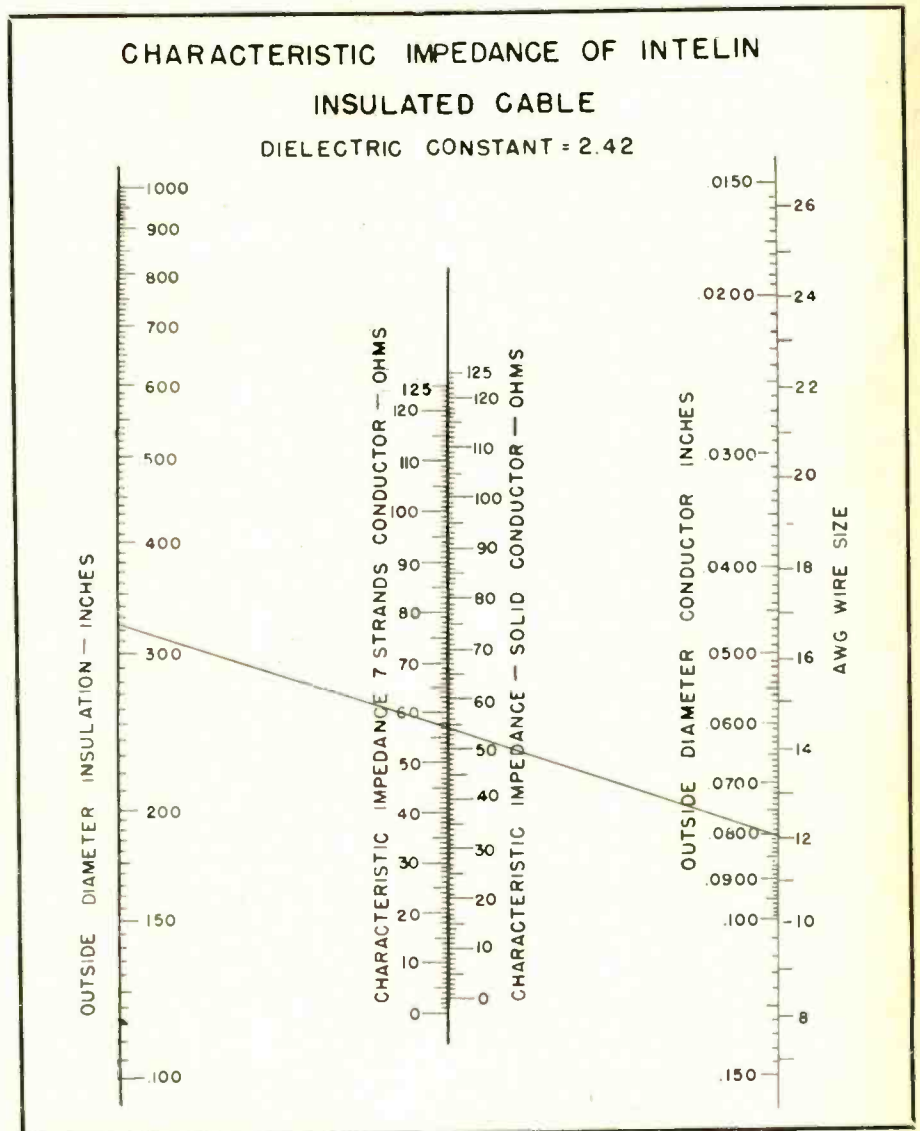

Fig. 2. Nomograph calculating the characteristic impedance of polyethylene insulated cable

to the non-uniform distribution of the electric and magnetic fields and, in the case of the unshielded twin, refraction of the electric field at the dielectric boundaries.

Dr. Greenfield³ has developed the following equations for L and C of the twin h-f lines

$$L = 0.281 \log(a-r)/r \text{ for } (a \gg d) \quad (14)$$

$$L = 0.281 \log[a + (a^2 - 4r^2)/2r] \quad (15)$$

$$C_s = [3.68k / \{\log(2aD^2 - 2a^3) / (dD^2 + da^3)\}] \quad (16)$$

$$C_u = (3.68k) / [\log a - r/r] \quad (17)$$

where

a = the separation of the conductor axis in inches

r = the radius of the conductor in inches

d = the conductor diameter in inches

D = the diameter of the insulation or in the case of the oval shaped cable it is the major axis width

k = the dielectric constant of the insulating material

L = the inductance of the cable in microhenries per foot

C_s = the capacitance of a shielded cable either round or oval shaped in $\mu\mu\text{f}/\text{foot}$

C_u = the capacitance of an unshielded cable, round or oval, in $\mu\mu\text{f}/\text{foot}$

It should be noted that all these equations are approximations, especially the equations for capacity and in particular equation (17) which will yield values that are anywhere from 15 to 75 per cent too high, depending on the size and shape of the cable. Obviously, therefore, the characteristic impedance obtained using these formulas is only a first approximation on which an experimental cable can be designed and later modified through actual measurements to conform to the desired values.

Attenuation

Probably the most serious problem that confronts a u-h-f cable engineer is that of designing low-loss transmission lines. For not only does the attenuation increase virtually exponentially with frequency and determine the power-handling capability of the cable, but also the importance of low loss becomes greater as higher frequencies are used. This is due to the fact that power is both costly and difficult to obtain as the frequency increases and only the ground wave can be utilized for space transmission. In many cases the most serious limitation to the use of u-h-f equipment has been the efficiency of its transmission lines, and if low attenuation h-f cables had not been developed, the use of high frequencies could not have reached its present-day proportions.

The total attenuation of the cable is due to two sources; the loss that occurs in the conductors and the loss due to the dielectric. At lower frequencies the first of these two factors predominates, but as the frequency goes up the dielectric loss becomes more important. The general formula for attenuation utilizing

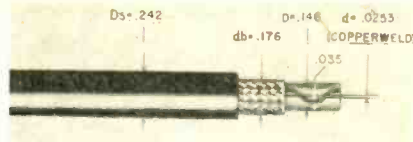

Fig. 3. Dimensions and characteristics of coaxial air-spaced low-capacitance cable

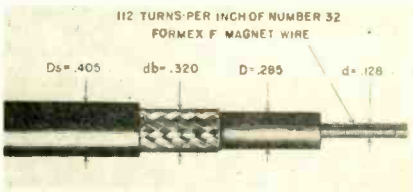

Fig. 4. Dimensions and characteristics of the specially designed spiral delay cable

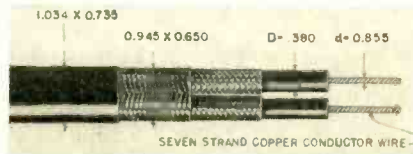

Fig. 5. Dual Coaxial cable used when a high degree of balance precision is necessary

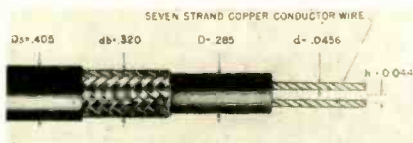

Fig. 6. Dimensions and characteristics of a dual twinax cable which also achieves a high degree of balance

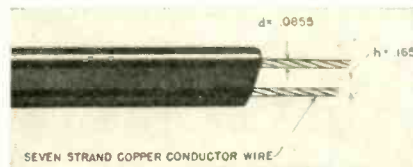

Fig. 7. A typical example of the less expensive antenna lead-in wire which will find wide application in the FM and television receiver field

the same assumptions made to obtain equation (2) is⁴:

$$\alpha = \frac{1}{2} R(C/L)^{-1/2} + \frac{1}{2} G(L/C)^{-1/2} \quad (18)$$

where

α = the attenuation in nepers per cm.

R = the resistance in ohms per cm.

L = the inductance per unit length

C = capacitance per unit length

G = shunt conductance per cm.

The first term in this expression is the attenuation due to the conductors which can be written by utilizing equation (2), the formula for resistance of a high frequency conductor,^{1,5,6} and converting the expression into decibels per 100 feet, in the form

$$\alpha_c = \frac{4.34 \times 7.6 \times 10^{-2} \sqrt{s \times f}}{Z_0} \left(\frac{R_1}{d} + \frac{R_2}{D} \right) \quad (19)$$

where

α_c = attenuation in db/100 ft due to the conductors

s = resistivity of copper in ohm-cm which is 1.724×10^{-6}

f = frequency in cycles per second

$$R_1 = \frac{\text{Resistance of inner conductor}}{\text{Resistance of copper}}$$

$$R_2 = \frac{\text{Resistance of copper}}{\text{Resistance of outer conductor}}$$

Z_0 = characteristic impedance of the line

d = diameter of the inner conductor in inches

D = diameter of the outer conductor in inches

The attenuation due to the two solid copper conductors of a coaxial line using a tubular outer conductor therefore becomes

$$\alpha_c = \frac{4.34 \times 0.1 \times \sqrt{s \times f}}{Z_0} \left(\frac{1}{d} + \frac{1}{D} \right) \text{ db/100 ft} \quad (20)$$

where f is now in megacycles per second and in the more general form this equation becomes

$$\alpha_c = \frac{0.434 f^{1/2} Z_0^{-1} (R_1/d + R_2/D)}{\text{db per 100 feet}} \quad (21)$$

where R_1 and R_2 are as defined in (19).

Minimum Attenuation

Equation (19) may be rewritten in the form

$$\alpha_c = \frac{4.34 f^{1/2} R^{1/2} D^{-1} Z_0^{-1} (D/d + n^{1/2})}{\text{db per 100 feet}} \quad (22)$$

where

$$R = \frac{\text{resistivity of the inner conductor}}{\text{Resistance of outer conductor}}$$

$$n = \frac{R_0/R}{\text{Resistance of inner conductor}}$$

and since both numerator and denominator are functions of D/d , which will be hereafter designated by p , an optimum value of p exists which will give minimum attenuation and Green, Liebe, and Curtis⁶ have shown it to be

$$\log_{10} p = (p + n^{1/2}) / 2.3 p \quad (23)$$

and for the special case where n is equal to 1, the optimum value for p is

$$p = D/d = 3.59 \quad (24)$$

which when substituted into the equation for Z_0 gives a characteristic impedance of approximately 77 ohms for an air-dielectric cable and 50 ohms for a polyethylene-insulated cable. From a graph showing the increase in attenuation due to the variation for a coaxial circuit⁶, it can be seen that near the optimum value the attenuation changes very little, but at the values of $p = 2.8$ and $p = 4.5$ there is a decided increase and a rather sharp slope for greater deviations.

¹H. H. Race and C. U. Larrick, "H-F Coaxial Line Calculation", *AIEE Transactions*. Vol 622, p. 536, 1942.

²W. L. Everitt, *Communication Engineering*, p. 116, 2nd edition.

³E. W. Greenfield, "Design Consideration of High Frequency Twin Conductor Cable." *Electrical Engineering*.

⁴"Ultra-High-Frequency Techniques", Brainerd, Koehler, Reich, Woodruff. D. Van Nostrand Company, Inc.

⁵"The Theoretical Attenuation and Power Rating (Thermo) of the R.F. Cables," *Intra-Service-British Technical Note. No. 146*.

⁶E. I. Green, F. A. Liebe, and H. E. Curtis, *The Proportional of Shielded Circuits for Minimum High-Frequency Attenuation*. *Bell System Technical Journal*, 1936, p. 248-283.

[To be continued]

USE OF MICROWAVES

THE CRYSTAL MIXER (*Fig. 1*) is a heterodyne mixer and detector which combines the received signals with the locally generated reference signal and detects the resultant beat frequency signals. If the received localizer and glide path signals have a frequency of 2640 and 2617 mc respectively, and the locally generated reference signal has a frequency of 2633 mc, then the beat frequencies generated in the mixer will be 7 and 16 mc respectively.

The cylindrical resonant chamber is tuned by means of a thumb screw that projects into the chamber. The input and output connections are coaxial terminals. A metal post, insulated from the chamber, is located in the center of the chamber; the silicon crystal is held between the post and the side wall of the chamber.

The received signals from the antenna are coupled into the chamber by a coaxial conductor which is terminated in two probe-like conductors extending into the cavity. The fixed frequency reference signals from the frequency multiplier are brought into the other side of the chamber by means of a short coupling loop. Because the outer conductor of the multiplier cable is at the anode potential (+400 volts d.c.) of the klystron multiplier, it is insulated from the wall of the chamber.

The microwave input signals are coupled to the detector crystal by the in-

DONALD F. FOLLAND

Engineer, Sperry Gyroscope Co., Inc.

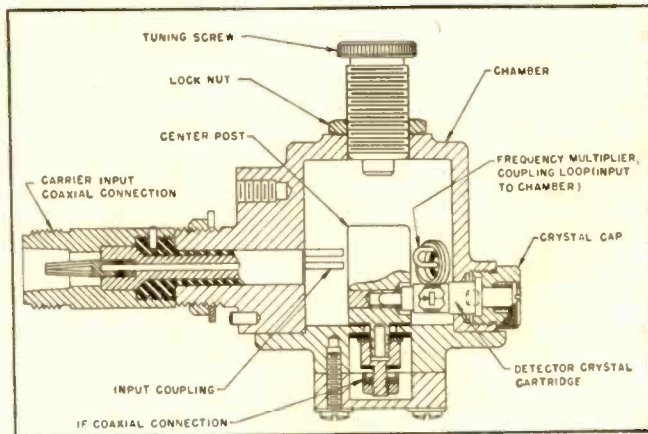

Fig. 1. Diagrammatic view of crystal heterodyne mixer and detector

ductive loop formed by the crystal and the walls of the chamber. The capacitance between the post and the floor of the chamber presents a low impedance to microwaves, and therefore acts as a shunt across the output cable carrying the intermediate frequency signals to the i-f amplifier.

I-F Amplifier

The i-f signals containing the localizer and glide path information are passed from the mixer to two similar

intermediate frequency amplifiers and audio detectors. *Fig. 2* shows a simplified block diagram of the arrangement for one channel (either the localizer or the glide path). The i-f signals are passed through three stages of amplification and then fed to the audio and avc detectors. The audio components of the i-f signals are detected by the audio detector which passes the signals to the audio amplifier. The audio components of the i-f signals are also detected by the avc detector which creates a voltage for controlling the grid bias on the i-f and audio amplifier tubes.

Fig. 3 also shows a simplified schematic of the audio and avc detectors. The output of the i-f amplifier is transformer-coupled to one section of the 6SL7 dual triode. The audio components (600 and 900 cycles) of the i-f signals are detected and appear as voltages across a portion of the cathode resistor. These voltages are coupled through a condenser to the grid of the audio amplifier tube.

The other section of the 6SL7 dual triode acts as an avc detector. As shown in *Fig. 3*, the i-f signals are passed to the grid of the triode. The grid of the tube is maintained at a steady negative bias (the cathode is at -85 volts, the grid at -90 volts, and the plate at ground potential). As the airplane nears the airport, the magnitude of the received signals increases and causes more plate current to flow in the tube. The voltage drop across a plate circuit resistor then provides a control voltage which becomes more negative as

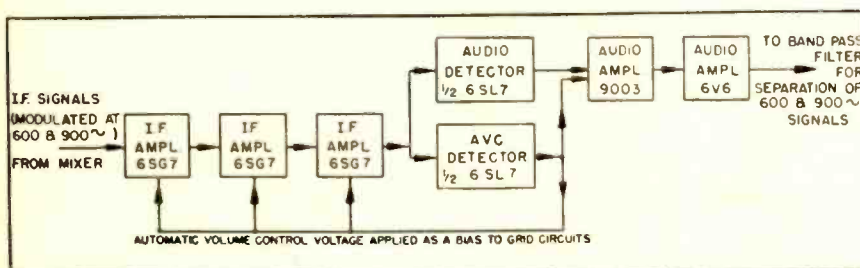
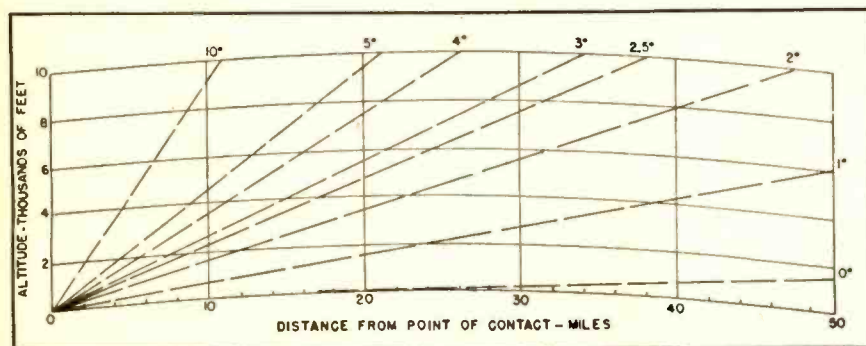

Fig. 2. (above) Block diagram of i-f and audio amplifier with avc circuit. (below) Glide path angle as function of altitude and distance from point of contact



FOR INSTRUMENT LANDING

Further design details of the M-W landing system are discussed in this concluding installment

the received signals increase; it is applied as grid bias to the i-f and audio amplifiers. The voltage is averaged by timing condensers; thus preventing instantaneous or transient voltage changes from affecting the steadiness of the avc action.

The overall effect of the avc is to decrease the receiver output as the received signal strength increases. This means that the voltages applied to the cross pointer meter become smaller as the airplane approaches the landing field. The result is the same as if the cross pointer meter were gradually desensitized as the plane neared the airport. This action prevents the landing path from becoming too narrow and difficult to fly.

"Course Softening"

The general effect of avc action (which is also referred to as "course softening" and "course broadening") is illustrated in Fig. 4. If the avc action were such as to keep the audio output of the receiver constant, regardless of received signal strength, the course would have a constant angular width over its complete range; this kind of avc action would produce a course width as shown by the dotted line in Fig. 4. It is obvious that such a course would make it difficult for the pilot to use the cross pointer meter during the last stage of the landing procedure. However, as previously described, the avc action is such that the receiver output decreases as the airplane nears the landing field; thus increasing the width of the course as measured by the cross pointer meter, and giving a course width characteristic as shown by the solid line in Fig. 4. This type of control produces a landing path which is easy for the pilot to follow all the way.

Audio Circuits

The audio circuits for each channel consist of the two-stage audio amplifier, the 600 and 900 cycle band-pass filters, and the two copper oxide bridge rectifiers. The output of the audio detector is passed through the two stage audio amplifier. AVC voltage is applied to the grid of the first audio amplifier. The

output of the second audio amplifier tube is connected to the 600 and 900 cycle band-pass filters as shown in Fig. 5. After separation of the 600 and 900 cycle signals, they are passed to two identical rectifiers which are connected in opposition. One of the audio frequency outputs becomes positive while the other becomes negative, and this condition provides comparative voltages which are applied to the cross pointer meter. Since the 600 and 900 cycle signals are not received simultaneously, electrolytic condensers are connected across the cross pointer meter so as to prevent any vibration of the meter needle and also give an average signal which is very suitable for use in connection with automatic landing equipment.

The method used in providing the cross pointer meter signals may be divided into five steps.

1. Separation of the 600 and 900 cycle signals by use of filters.
2. Rectification of the 600 and 900 cycle signals to opposite polarities.
3. Averaging of the two resulting signals.
4. Application of the two resulting signals to meter.
5. Meter indication is algebraic sum of the two signals.

Safety Circuit

Each channel is provided with a safety circuit for advising the pilot when satisfactory landing path signals are being received. The circuit consists of one stage of audio amplification plus a cathode follower. The safety lamp is connected directly between cathode and ground of the cathode follower. The cathode follower is normally self-biased to approximately 45 volts between cathode and ground; the presence of sufficient audio voltage to give a satisfactory signal at the cross pointer meter is detected by the cathode follower and causes the cathode voltage to rise to 75 volts, causing the neon tube to fire. For any further increase in signal, the neon tube stays lit. The action of the

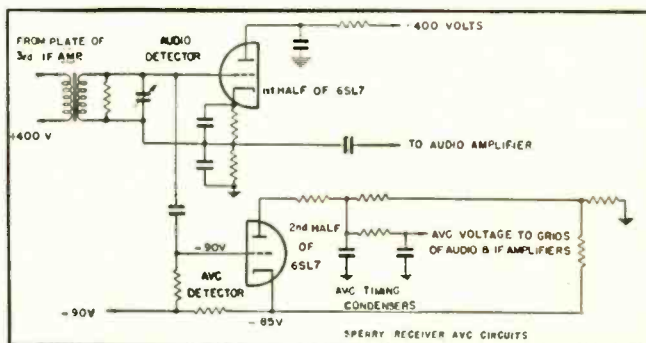
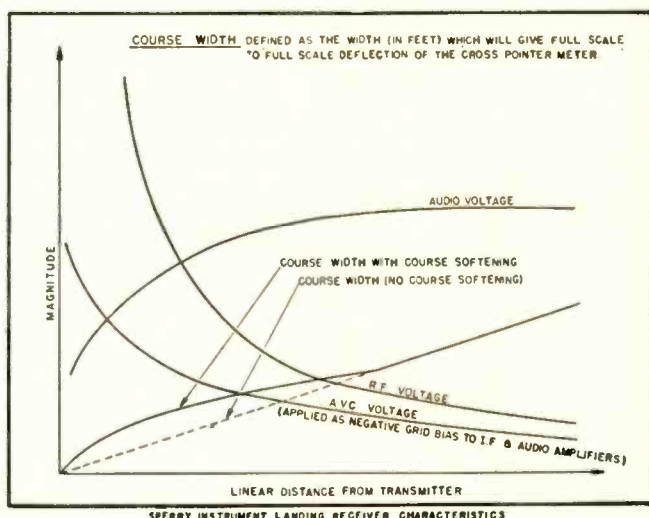

Fig. 3. Simplified schematic diagram of the audio and a-v-c detectors

Fig. 4. A-v-c action produces relative course-softening, as graphed.



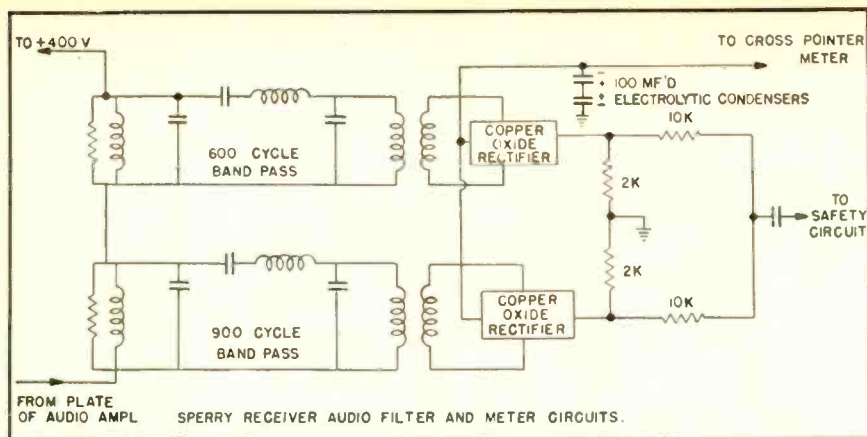
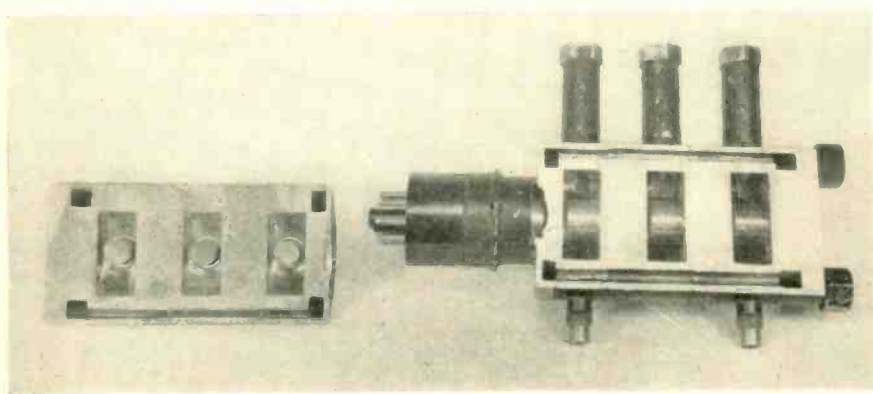

Fig. 5. (above) Audio-amplifier output is filtered by 600 and 900 cycle band-pass networks for meter indication. Fig. 6. (below) Paddle-tuned klystrons have tuning range of 15mc



cathode follower tube is similar to that of an infinite impedance detector. The safety lamp lights before a/c voltage is developed.

The only input voltages required for the receiver are +400, -90, and +24. The 24-volt supply is obtained from the airplane's generator and is used for the receiver filament circuits and for the motor end of the motor-generator which supplies the +400 and -90 voltages.

Regulation of the +400 and -90 volt supplies is obtained by means of a field control arrangement on the shunt motor of the motor generator. An electronic regulator circuit is used for the field control. (Details of this circuit are not yet available.) The -90 volt supply is further regulated by a VR90 gas tube. Adequate filtering for high and low frequency ripple is provided by mica and paper condensers.

Fixed Grid Klystrons

All the klystrons used in the transmitter are of the so-called fixed grid type and are narrow band tubes. They are supplied with tuning paddles which operate directly in the resonant chambers of the tube, Fig. 6. With these paddles a tuning range of 15 mc can be obtained. Klystrons, due to the fact that their resonant circuits are of comparable size to the wavelengths used,

are temperature-sensitive. For example, if a klystron is used as an oscillator and is subjected to wide ambient temperature changes, its frequency of oscillation will vary as the temperature changes. In the case of a multiplier or amplifier tube whose operating frequency is determined by a quartz crystal, the output power will vary when the tube is subjected to varying ambient temperature. For this reason, a cooling system is set up in the microwave deck to keep the three klystrons at a fixed operating temperature.

The cooling system consists of a liquid circulation pump, a thermostatically controlled valve and a liquid reservoir. The pumping system circulates an ethylene glycol and water mixture through water jackets which are integral parts of the klystrons, where the liquid is heated,

after which it passes through the thermostatically controlled valve. This valve which operates in a manner similar to the thermostat on an automobile, allows the liquid to circulate only through the pump and the tubes until the proper operating temperature is reached. After this temperature is reached, the valve shunts the proper amount of liquid through the radiating system for cooling.

It is thus possible to keep the tubes at $85^{\circ}\text{C} \pm 1^{\circ}$, which is well within the range required for satisfactory operation

Trailers

The glide path and localizer trailers are similar except for features demanded by the different antenna structures and different alignment procedures. Both trailers have heavy jacks on each of the four corners. These jacks are used to provide a firm foundation for the trailers and to take the load off the tires and springs. The trailers are equipped with electric heaters for winter operation and a ventilating fan for summer. Communication equipment is installed in both trailers to allow radio contact between trailers and between trailer and aircraft. This equipment is used only during experimental testing and demonstration, as all communication would normally flow through the airport control tower.

Field Tests

In the development of the microwave instrument landing equipment, approximately 1000 flights have been made during the period between December 1941 and January, 1946. During this time approximately 3000 instrument landing touchdowns have been made at various airports, and of these landings a good number were made with the pilot under the hood so that he received no visual aid except from his instruments. Including flights made on several tours, the instrument landing system has been operated at the following airports: Harrisburg, Wright Field, Cincinnati, Pittsburgh, Westfield, La Guardia, Washington National Airport, Aviation Country Club, Banana River Naval Air Station, Albany, Ballston, Republic Airport, and MacArthur Field. These oper-

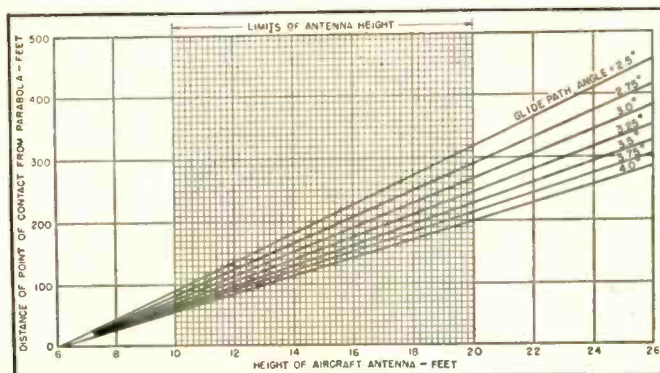

Glide path angle as a function of point of contact and height of aircraft antenna

ations give assurance that the system will work with all kinds of terrain.

The Pittsburgh airport is on top of a hill with practically no obstructions; the Westfield airport is hemmed in by mountains; Banana River Naval Air Station is surrounded by water and is built on a sand bar. At none of these airports was there evidence that micro-waves would not be suitable for that airport. All the flights at the airports were checked by means of the optical instruments to determine if any course bends or shifts were present; none were noted. Since the localizer was capable of being aimed optically, predetermined courses over specific distant points have been set up with the aid of an accurate compass and theodolite. When these courses were flown, the accuracy of the setting was confirmed.

Bibliography

Daniel Guggenheim Fund for the Promotion of Aeronautics, Inc. Equipment Used in Experiments to Solve the Problems of Fog Flying. 57 pages. March, 1930.

Diamond, H. Performance Tests of Radio System of Landing Aids. National Bureau of Standards Research Paper RP-602. (Reprint from Bureau of Standards Journal of Research, 11, October 1933). October 1933.

United Air Lines Instrument Landing System. *Aero Digest*, Vol. 28, No. 6, p. 60. June 1936.

Blind Landing; the Lorenz-I. T. and T. Blind Landing System, Installed at the Indianapolis Airport. *Electronics*, 10, p. 25-26. July 1937.

Diamond, Harry and Francis W. Dunmore Experiments with Underground Ultra-High-Frequency Antenna for Airplane Landing Beam. National Bureau of Standards Research Paper RP-1006. (Reprint from Journal of Research of the National Bureau of Standards, 19. July 1937). July 1937.

Status of the Instrument Landing Systems, by W. E. Jackson. *Proceedings of the Institute of Radio Engineers*, New York. Vol. 26, No. 6, p. 681-99. June 1938.

Under the Weather; Instrument Landing. *Fortune*, Chicago. Vol. 17, No. 6, p. 62-63, 104, 106. June 1938.

Air Track System of Aircraft Instrument Landings, by G. L. Davies. *S.A.E. Journal*, New York. Vol. 43, No. 4, p. 18. (1938 Annual Meeting, Detroit, Mich. Jan. 10-24, 1938). Oct. 1938.

A High Frequency Oscillator and Amplifier. Russell H. Varian and Sigurd F. Varian. *Journal of Applied Physics*. Vol. 10, p. 321-327. 1939.

Aircraft Instrument Landing Research at the Massachusetts Institute of Technology. E. L. Bowles. *Proceedings of the Institute of Radio Engineers*. Vol. 27, p. 409. 1939.

Television Principle Applied to Blind Landing by the R.C.A. Interavia, Geneva. No. 631, p. 1-3. March 1939.

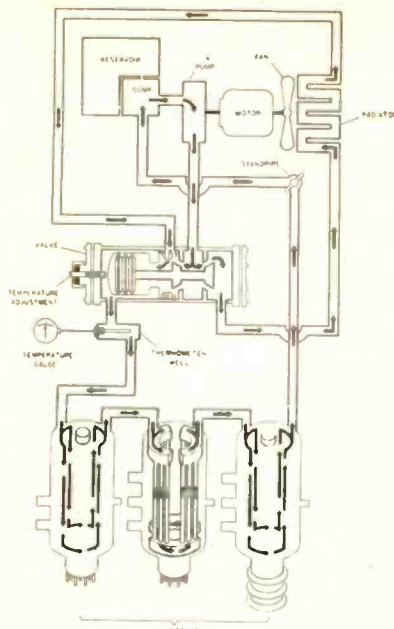

Klystron cooling system

Bendix Landing System. *Aviation*, New York. Vol. 38, No. 4, p. 41-42. (Also *Canadian Aviation*, Toronto, April 1939, Vol. 12, No. 4, p. 19) April 1939.

Radio Ranges, Marker Instrument Landing System; Tabulated Description. *Aero Digest*, New York. Vol. 35, No. 3, p. 101-02. September 1939.

A 500 Cycle Blind Landing System, by Edward Nelson Dingley, Jr. *Aviation*, New York. Vol. 38, No. 7, p. 60-61, 92. July 1939.

Instrument Landing of 40 cm. Waves, by Don Fink. *Aviation*, New York. Vol. 38, No. 11, p. 26-27, 78. November 1939.

CAA-MIT Microwave Instrument Landing System, by E. L. Bowles, Barrow.

Hall, Lewis and D. Kerr, *American Institute of Electrical Engineers*. Technical Paper, New York. No. 40-44. January 1940.

Flight Ray, a Multiple Instrument Indicator, by Preston R. Bassett and Joseph Lyman. *Journal of the Aeronautical Sciences*. New York. Vol. 7, No. 5, p. 199-204. March 1940.

Cathode-Ray Tube Used as Aircraft Instrument Indicator; Flight Ray Indicator. *Electronics*, New York. Vol. 13, No. 3, p. 36. March 1940.

Development of CAA Instrument Landing System at Indianapolis, by W. E. Jackson, A. Alford, P. F. Byrne and H. B. Fisher. *Electric Communication*. New York. Vol. 18, No. 4, p. 285-302. April 1940.

The Civil Aeronautics Authority Instrument Landing System Installed at Indianapolis, Ind. By Henry I. Metz. *Journal of the Aeronautical Sciences*, New York. Vol. 7, No. 9, p. 383-87. July 1940.

Instrument Landing of Aircraft. *Electrical Engineering*, New York. Vol. 59, No. 12, p. 495-502. December 1940.

Latest Type AAF Blind Landing Equipment, by Montgomery. (Federal Telephone and Radio). *Electronic Industries*, p. 100-103. January 1945.

The CAA Instrument Landing System, Part I. By Caporale. *Electronics*, p. 116-124. February 1945.

The CAA Instrument Landing System, Part II. By Caporale. *Electronics*, p. 128-135. March 1945.

Microwave Techniques, by F. Jenks. *Electronics*, p. 120. Oct. 1945.

Ground Controlled Approach for Aircraft, by Watson. *Electronics*, p. 112. November 1945.

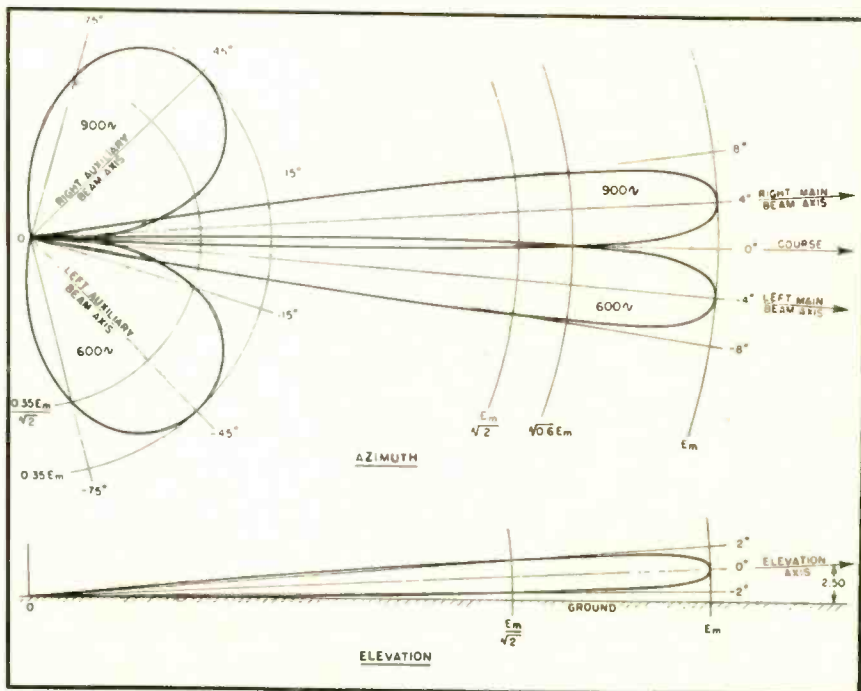

Radiation pattern as measured for transmitting antenna, showing resultant glide path of aircraft

RECENT PUBLIC DEMAND, especially in small semi-portable receivers, has been for loop reception. Tuning of loops has been accomplished in the past by variable condensers.

Efforts were made by research and development engineers to adapt permeability tuning to loop reception and many abortive attempts were made in this direction. It must be remembered that the loop itself, being an inductive device, normally calls for capacitance tuning. Simple calculations prove, however, that permeability tuning is applicable to the loop circuit tuning when proper constants are chosen.

On the basis of the equation

$$h_{\text{eff}} = \frac{2\pi AN}{\lambda} \dots \dots \dots (2)$$

absolute sensitivity depends on the number of turns, so that in order to get comparable results, the loop employed in a permeability tuned system should have the same number of turns or same inductance as when capacitively tuned. With this thought in mind, we may go into consideration of frequency ranges, which will lead to some interesting conclusions.

In a high-impedance condenser-tuned system the frequency range may be expressed as follows

$$\frac{f_1}{f_2} = \sqrt{\frac{C_2 + C_0}{C_1 + C_0}} \dots \dots \dots (6)$$

where f_1 and f_2 are maximum and minimum frequencies.

C_1 and C_2 are maximum and minimum capacitances of the variable condenser, and C_0 is the residual capacitance of the circuit. For practical purposes in broadcast receivers, $L = 180-200 \mu\text{h}$; $C_2 = 50-60 \mu\mu\text{f}$, and $C_1 = 375-450 \mu\mu\text{f}$. $C_0 = 30-60 \mu\mu\text{f}$, so that a frequency range for 1600-540 kc is obtainable and $f_1/f_2 = 3.0$.

In permeability tuning the inductance of a loop L_a in series with a variable tuner may be determined from the maximum and minimum inductance of the tuner L_0 , μ_{eff} and desired f_1/f_2 in the following manner:

$$L_a = L_0 \frac{\mu_{\text{eff}} - \frac{f_1^2}{f_2^2}}{\frac{f_1^2}{f_2^2} - 1} \dots \dots \dots (7)$$

Thus for a given frequency range, we arrive at a certain value of loop in-

TABLE 1

μ_{eff} of Tuner	Permissible L_a	Sensitivity drop
9	6.7 μh	-25 db
10	20 "	-10 "
12	93 "	-3.4 "
16	200 "	0

Inductively Tuned

W. J. POLYDOROFF

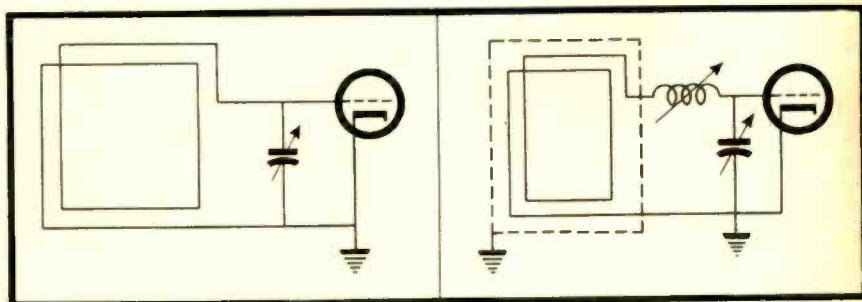

Fig. 1. (left) Conventional unbalanced loop tuned by variable capacitance. Fig. 2. (right) Equivalent circuit of inductively tuned loop

ductance expressed in terms of minimum inductance of the tuner for different values of effective permeability. If now we limit the total minimum inductance of the circuits L_a and L_0 to practical capacitance limits and by the amount of inductance to be wound on a small size tubing with permissible Q , we arrive at the following practical values of L_a for different tuners, based on $(f_1/f_2) = 8.5$ (frequency range 550-1600 kc).

The data in Table 1 are based on the practice of winding a single coil on $1/4$ " tubing with universal windings to an L of the order of 100 μh with a Q about 100 at 1600 kc. Obviously an increase of inductance of the coil will decrease both the Q and effective μ (turns running away from the iron) so that nothing is gained in overall sensitivity.

Now referring back to the equation for effective height we may write:

$$\frac{h'_{\text{eff}}}{h_{\text{eff}}} = \frac{N'}{N} = \sqrt{\frac{L_a}{L_0}} \dots \dots \dots (8)$$

Thus if we take as an example a loop of 200 μh and express its sensitivity in db we get the figures of sensitivity in Table 2.

This will give us a practical comparison

of a permeability tuned loop with a condenser tuned loop. Only by using a tuner having $\mu_{\text{eff}} = 16$ are we permitted to use a loop of the same sensitivity as in condenser tuned systems and still cover the range.

Q Requirements

It is entirely immaterial from the standpoint of absolute sensitivity whether the signal is picked up by the loop and delivered directly to the terminals of the condenser or through a series inductor. The Q in equation (4) emphasizes the fact that the Q of the inductor should be at least as high as the Q of the loop. In actual measurements in the laboratory it was ascertained that insertion of a high Q inductor in series with the loop (Q of the inductor being higher than the Q of the loop) actually improves this sensitivity. The reverse holds true for an inductor having Q lower than the loop.

The loop circuits tuned directly or through a low-impedance network are now shown side by side for capacitive and permeability systems. Dotted lines indicate shielding around loops.

Fig. 1 shows the orthodox unbalanced

TABLE 2

Effective μ of tuner	Loop Inductance	Total min. ind.	C at 1600
9 one coil	.067 L_0	100 6.7	100 $\mu\mu\text{f}$
10 " "	.2 "	100 20	90 "
12 two coils	.465 "	200 93	35 "
16 " "	1.0 "	200 200	25 "

LOOP CIRCUITS

Low-impedance loops with inductive tuning offer advantages over whip antennas for mobile use, as explained in this concluding installment

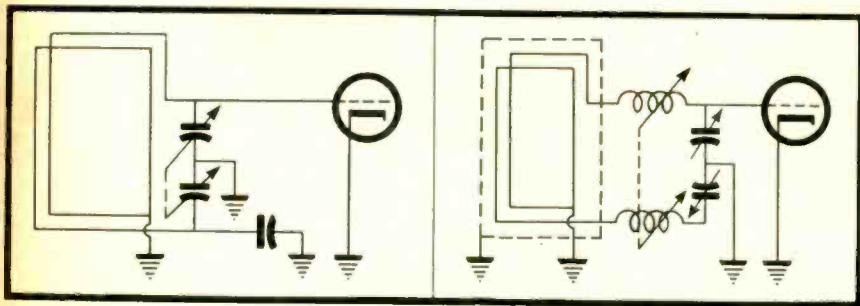

Fig. 3. (left) Center-tapped system balanced to ground. Fig. 4. (right) Balanced system with inductive tuning

loop tuned by a variable condenser. Additional shielding around the loop has been often employed with noticeable improvement in this construction.

The equivalent circuit is shown in Fig. 2, where the loop and condenser are of fixed values and the circuit is tuned by a variable inductor. The loop should be on the ground side of the circuit to reduce the antenna effect.

The circuits become more costly when the balanced system of Fig. 3 is used. Here we have a center-tapped-to-ground loop with both ends connected to a variable condenser. The condenser has a common rotor and two sets of stator plates. The value of capacity is double that in Fig. 1, since both condensers are in series. If one input tube is used, the other end of the circuit may employ a small balancing condenser. Fig. 4 shows a similar balanced system in which two equal variable inductors are inserted in each branch of the circuit; two adjustable condensers with a ground between act as the circuit and balancing capacitors. We have already indicated that for high efficiency the loop tuner should consist of two coils, each using its own movable core. The two coils of Fig. 4, as will be described later, form part of a single tuner in order to realize μ_{eff} 12-16. The loop may be inserted in series with these two coils and by the simple expedient of center tapping the loop a balanced system is secured.

Fig. 5 shows the usual low impedance circuit so popular in aircraft and other

D.F. installations where a loop may be a considerable distance from the receiver with a connection through a transmission line to the primary of the transformer. This system permits use of a single loop over a wide frequency range by inter-connecting different transformers whose secondaries determine the frequency ranges tunable by the same condenser. The mathematics of this circuit is well known and has already been discussed. A center-tapped loop and a center-tapped transformer provide a balanced system. Transformers of highest possible coefficient of coupling are used for maximum efficiency and can be best realized by a pot-type iron-core coils. Fig. 6 shows the identical circuit for inductive tuning. The tuning element acts as a variable coupling transformer whose primary winding is bunched together towards the high frequency end of the tuning coil.

Thus we may see from the above

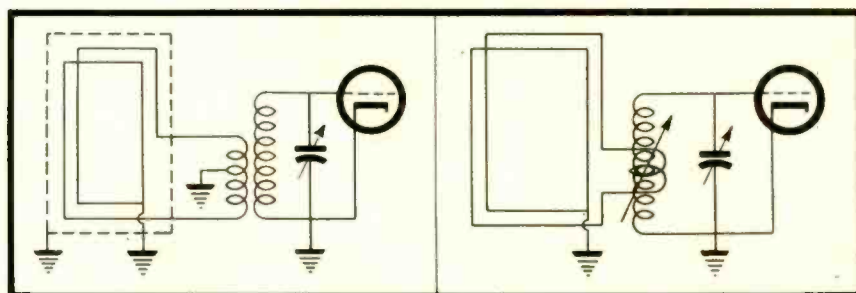

Fig. 5. (left) Conventional low-impedance loop circuit. Fig. 6. (right) Inductively tuned low-impedance loop circuit

circuits and these discussions that the commercial varieties of permatuners producing μ_{eff} 8-9 are not at all suited for loop antenna tuning.

Single Core Tuner

Fig. 7 shows a single core commercial tuner. Recently, to meet the demands of extended range, the core and tubing have been elongated to a length-to-diameter ratio of over 8 and even 10 with which an expected range using thin tubing will be from 10-12. If the coil is a single layer solenoid, the Q of such construction is hopelessly low. If used for loop reception the circuit gain will be low and the noise level high.

The range of a single core tuner may be improved by a stationary sleeve of magnetic material spaced around the coil. An effective permeability of 10 may be obtained with a high Q progressive universal coil. Such a tuner, when used in a directly tuned loop, will yield a sensitivity of -10 db as compared with a condenser tuned loop.

When two inductors are used side by side as shown in Fig. 8, we have the double advantage of more space for the winding which enables us to increase Q and the total minimum inductance of the tuner and also increase the effective permeability (one core acting as a return path for the other) which may go up to 12 so that the sensitivity and quality of reception are improved, this system being -3.4 db in sensitivity.

If two stationary yokes are added at both ends of the structure of Fig. 8, we obtain the most efficient tuner. See Fig. 9. Its effective permeability is of the order of 16-20, because at its maximum inductance position the magnetic structure approaches a toroidal ring. At that position, four magnetic caps (the caps are equal to the thickness of the tubing) are interposed which contribute to the smooth adjustment. Additionally, this structure does not suffer the drop of effective permeability at its maximum position when it is closely shielded.

With the movable cores each 1½"

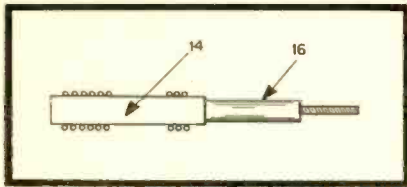

Fig. 7. Design of a single-core commercial inductor; length-to-diameter ratio is 8-to-1 or 10-to-1

long and $\frac{1}{4}$ " diameter and using a reasonably thin tubing, a pair of progressive universal coils will give a minimum inductance of about 22 μ h with the Q of the order of 90 at 1600 kc, which increases to 115-120 at the lower frequency end. In accordance with the findings of tuning range consideration, this type of inductor will permit employment of full size loop at no sacrifice of sensitivity.

Tuners of Figs. 8 and 9 with two coils of equal inductance can be employed in a high-impedance balanced system as shown in Fig. 6, in which case the loop is connected in series between two coils and center-tapped to ground.

Twin-Core, Twin-Yoke Tuner

Fig. 10 shows a complete circuit employing twin-core, twin-yoke tuner, which is operated simultaneously with a single-core oscillator coil. Considerable difficulty was found in obtaining accurate tracking of these two circuits, so physically unlike. A shunt coil is added to the oscillator coil for this purpose and it must have an adequate Q (50 or better) in order to use it to "split" the oscillator windings of the pentagrid converter. The inductor of Fig. 9 has another desirable feature: one of its yokes, farthest from the entrance of the cores, can be made movable with respect to the coil. This expedient gives us a low-frequency point of tracking, practically independent of the other points. If this method is employed the tracking is as follows:

Tracking procedure. Having established a frequency curve for the oscillator, the oscillator coil and condenser are adjusted so the dial settings correspond throughout the range. As the next step all cores are withdrawn and rough adjustments for loop tuner are made to correspond to 1600 kc; the cores are then moved into a position correspond-

ing to 1500 kc and accurate tracking is obtained by tuning the loop circuit condenser. The cores are then moved to the position of 1000 or 900 kc and the pair of tuner cores is adjusted to obtain the tracking at that point. After this second adjustment it is advisable to come back to 1500 kc to correct the capacity error resulting from the core displacement, then back to intermediate point

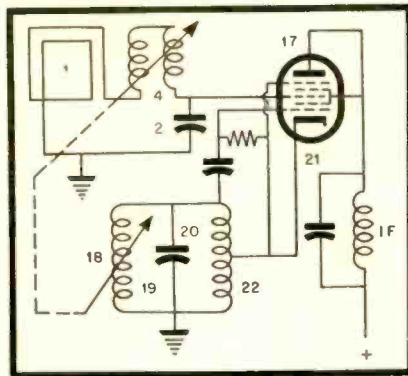

Fig. 10. Ganged inductively tuned loop and local oscillator system

and repeat adjustment. If the circuit constants are correct and permeability of cores is uniform, no further adjustment is necessary. However, it is advisable to re-align the loop circuit at the position corresponding to 600 kc, which is made by sliding the low frequency end yoke over the coils. Practice shows that this is an entirely independent adjustment, allowing three degrees of freedom in the adjustment procedure.

Signal-to-noise ratio. As mentioned before, this is really the main criterion of reception. Since the tube noises in recent tubes have been brought down to a negligible amplitude, the principal source of the noise is thermal agitation in the input circuit.

Much has been written recently on the input circuit noise that can be condensed to a few simple facts.

1. In general, thermal agitation noise, or more precisely "equivalent-noise-sideband input varies inversely with antenna stage gain". The higher the gain, the better the signal-to-noise ratio.

2. Signal-to-noise ratio varies as the square root of loop Q where the loop is the sole inductance in the circuit. Hence, emphasis on Q again.

3. If a receiving loop is part induct-

ance of the total circuit (such as Figs. 2, 4, 5, and 6) the signal-to-noise ratio is decreased (noise increased) in proportion to $\sqrt{L/L_0}$, where L is total inductance and L_0 same of the loop.

4. In the low impedance circuit transposition yields results similar to that just described.

5. The difference between signal to noise of directly tuned loop and a low impedance or inductive loaded loop circuit varies between 6-10 db, as compared with item 2.

6. Calculated and measured values of threshold signal at which a signal-to-noise ratio of 4 to 1 exists indicate that an insensitive receiver, for example, a four-tube superheterodyne, does not have enough grid input sensitivity to respond to thermal agitation noise.

7. High sensitivity receivers, having one or two r-f stages, are limited by signal-to-noise ratio, yet aircraft installations still use low-impedance loop systems.

8. In receivers employing an ac-dc filament circuit, the noise directly transmitted from the line is far greater than thermal agitation noise.

9. Man-made static greatly over-rides the above considerations for quiet reception. The way to reduce this noise is to employ balanced or shielded tops.

Conclusion

In conclusion we may state that best reception will result from directly tuned loops, tuned by a condenser, provided the antenna effect is entirely eliminated. Since the balancing can be economically obtained in the low impedance loop it is preferred to unbalanced high-impedance systems. The inductance tuned loop systems offer about the same reception and same advantages as low impedance loop circuits. In all cases it is paramount to have high Q in all components of the input circuit. The practice of building up a high Q loop and placing it right against the chassis is one way of defeating this purpose. One r-f stage is always advisable for loop reception since in addition to more gain it eliminates the load of the pentagrid converter on the input circuit. If iron core tuning is selected for economy and compactness, wide tuning range and high Q iron core inductors are essential.

On the strength of experiments made for police radio it is reasonable to expect that loop reception may entirely replace whip antennas for auto receivers. Because the distance between the loop and the receiver necessitates a cable, the low impedance system is better suited to this case. The forthcoming plastic top cars will have their loop antenna mounted inside the car.

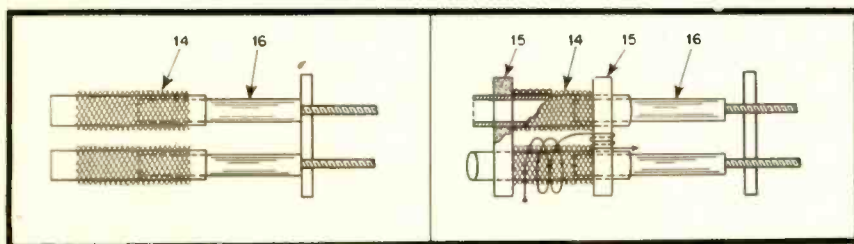
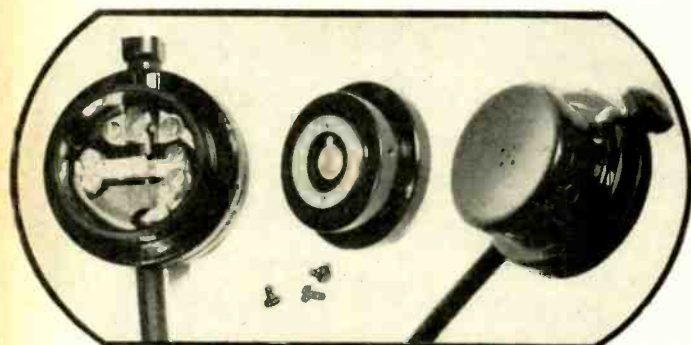

Fig. 8. (left) Two inductors side-by-side conserves space and increases Q. Fig. 9. (right) End yokes provide most efficient overall design.



(Left). First New York City police radio transmitter was installed at Centre Street headquarters by Western Electric in 1932. Here Superintendent Allan and Assistant Superintendent Morris of the Telegraph Bureau view the 500-watt a-m transmitter with Chief Engineer Rochester. (Right). The 300-meter Centre Street transmitter, WPY, for communication with ships.

POLICE RADIO EQUIPMENT



Anti-noise carbon microphone as used in modern police equipment. It features low-frequency response and rugged recessed mouthpiece for good signal-to-noise ratio —*Aviometer photo.*

Today, fm has found acceptance for police radio communication. The 50-watt transmitter-receiver illustrated at the right typifies the main-station frequency-modulated equipment used by hundreds of municipal police departments.—*Photo courtesy of Fred M. Link*



In 1934 this 50-watt u-f transmitter with 500-watt amplifier was installed by W. E. in the National Newark & Essex Bank Building

Construction of modern police radio equipment presents marked contrast to first installations 14 years ago. Temco 1000-watt radiotelephone-telegraph transmitter (closed) for frequency-modulated point-to-point communication service. This unit is in use by the Arizona state highway department.

(Open)—Accessibility is featured in the 250-watt fm transmitter-receiver designed by Fred M. Link. Vertical rack mounting is utilized, with full doors, front and back

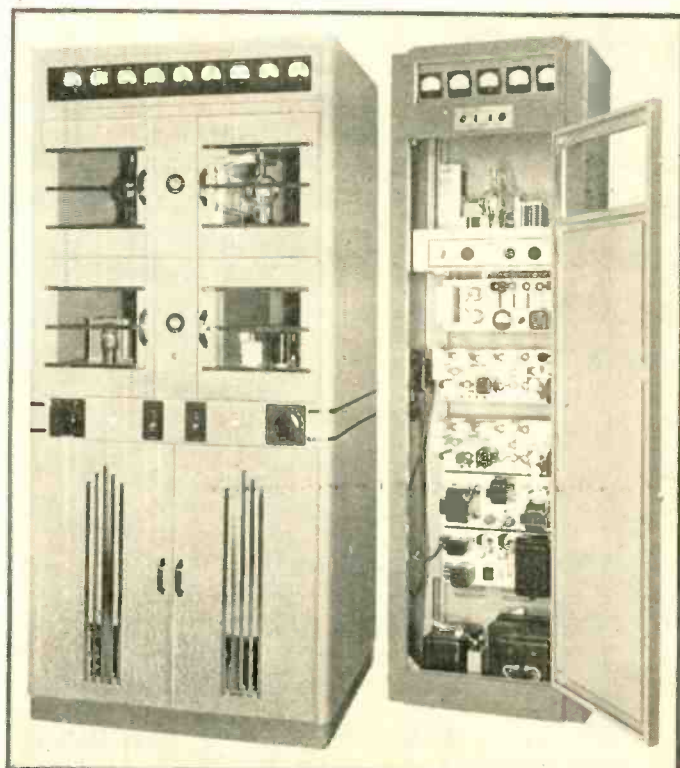

RADIO DESIGN WORKSHEET

NO. 48 - REACTIVE FEEDBACK FACTORS

REACTIVE FEEDBACK FACTORS

With R_k fairly large, the circuit shown in Fig. 1 becomes largely linearized from the standpoint of amplitude distortion, as may be seen from the equivalent tube characteristics plotted for a typical circuit in Fig. 2. That linearity is achieved by negative feedback may be shown algebraically:

$$A_f = \frac{1}{B(1 - 1/AB)}$$

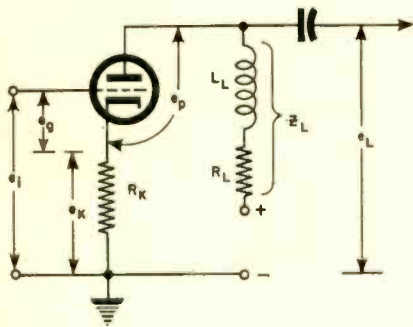

Figure 1

where A_f is the stage amplification with feedback. $B = e_k / (e_k + e_L)$, and A is the amplification with grid returned to cathode.

When B is a substantial fraction of unity, A_f becomes largely independent of variations in A , and the output is practically proportional to the input for a single frequency.

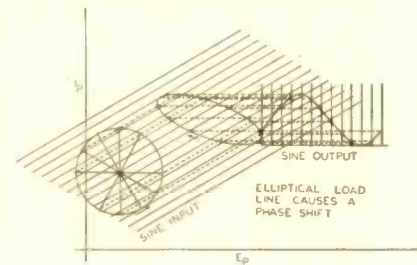

Figure 3

With sinusoidal input, a truly linear circuit affords a sinusoidal output, the magnitude of which may be represented as I_o , or $i_p = I_o \sin \omega t$. This output current flows through Z_L , whence the $e_p - i_p$ relation may be derived:

$e_p^2 + 2R_L e_p i_p + i_p^2 Z_L^2 - \omega^2 L^2 I_o^2 = 0$ showing that the $e_p - i_p$ relation is a double-valued function.

To solve the circuit of Fig. 1 graphically for a single frequency, the elliptical load line may be drawn upon the linear portion of the equivalent tube characteristics shown in Fig. 2. The resulting characteristics of tube and load then appear as depicted. Should the ellipse drop down into the curved portion of the characteristics, the analysis will be in corresponding error.

This ellipse is centered on the operating point, and it will be evident from Fig. 3 that its influence on the output voltage is to cause a phase shift.

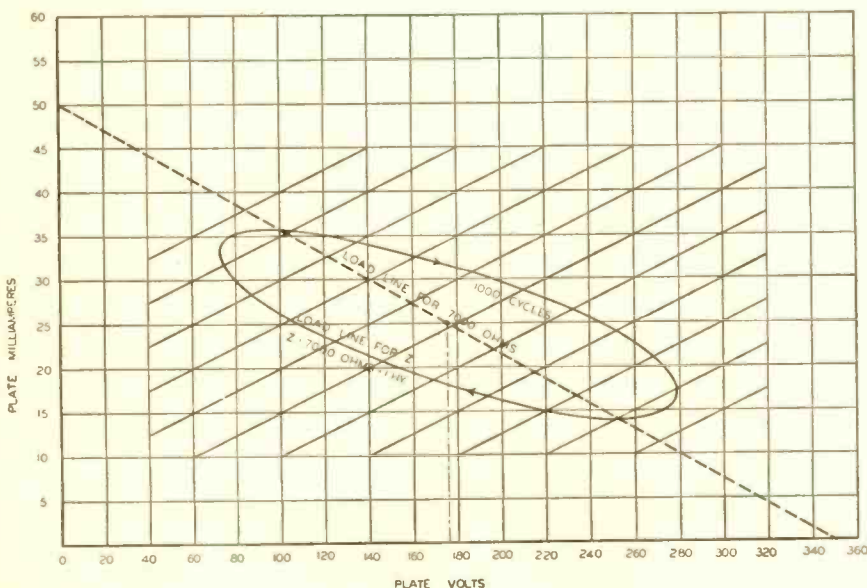

Figure 2

The primary advantage of locating the ellipse is to determine the operating region upon the characteristics, and this elementary construction suffices to reveal the approximate frequency at which severe distortion may be anticipated.

Excursions of i_p have as limits $\pm R_L I_o$; intersections of the quiescent current ordinate with the ellipse are at $\pm I_o \omega L$; voltage excursions of e_p have as limits $\pm I_o Z_L$. The center of the ellipse is the quiescent point.

In the event that R_k and Z_L are interchanged, as in Fig. 4, so that the phase shift occurs in the feedback mesh instead of the output mesh, the voltage fed back to the grid is no longer 180° out of phase with the input voltage, but leads it. The voltage e_o applied to the grid, regarding the tube as essentially linearized, may be determined as follows:

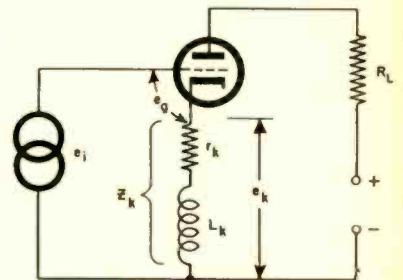

Figure 4

Let e_o equal the grid-cathode voltage; e_k equals the feedback voltage developed across Z_k ; e_i equals the input or source voltage; R_L equals the plate load resistance, as shown in Fig. 4. A is the stage amplification.

$$e_o = e_i - e_k$$

$$e_k = A e_o Z_k / (Z_k + R_L)$$

$$e_i = e_o + A e_o (r_k + j\omega L_k) / (r_k + R_L + j\omega L_k)$$
 Representing the complex term as $Z_f \epsilon^j \theta$, the input voltage is seen to be equal to the resultant of two voltages separated by the angle θ .

$$e_i = e_o + A e_o Z_f \epsilon^j \theta$$

Replacing e_o by its equivalent e_o ,

$$e_o = e_i / (1 + A Z_f \epsilon^j \theta)$$

This is the effective grid-cathode voltage, from which the plate current is displaced 180° . It is apparent that the magnitude and phase of the feedback voltage is a function of frequency, because of the presence of the impedance element.

KAAR

**INSTANT
HEATING**

MOBILE FM

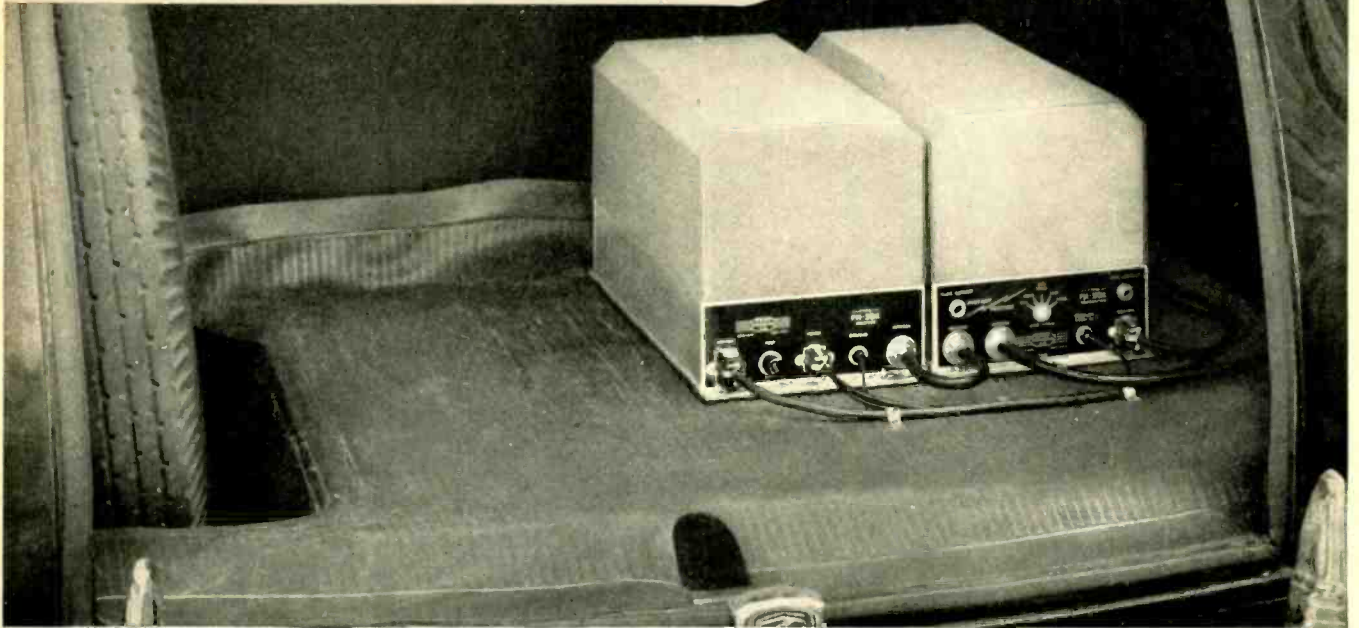

Now available! An FM Radiotelephone with a truly **NATURAL** voice quality!

New KAAR FM radiotelephones offer an improvement in tone quality which is surprising to anyone who has had previous experience with mobile FM equipment. The over-all audio frequency response through the KAAR transmitter and receiver is actually within plus or minus 5 decibels from 200 to 3500 cycles! (See graph below.) This results in vastly better voice quality, and greatly improved intelligibility. In fact, there is appreciable improvement even when the FM-39X receiver or one of the KAAR FM transmitters is employed in a composite installation.

KAAR FM transmitters are equipped with instant-heating tubes, thus making it practical to operate these 50 and 100 watt units from the standard 6 volt ignition battery without changing the generator. Inasmuch as standby current is zero, in typical emergency service the KAAR FM-50X (50 watts) uses only 4% of the battery current required for conventional 30 watt transmitters. Battery drain for the KAAR FM-100X (100 watts) is comparably low.

For full information on new KAAR FM radiotelephones, write today for Bulletin No. 24A-46.

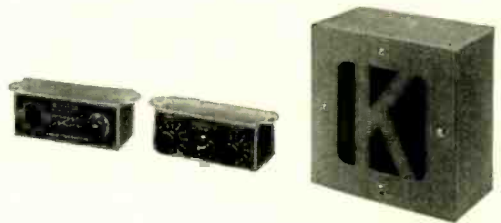

KAAR LOUD SPEAKER, remote controls for transmitter and receiver (illustrated above) and the famous Type 4-C push-to-talk microphone are among the accessories furnished with the equipment.

IMPROVED OVER-ALL FREQUENCY RESPONSE THROUGH KAAR FM TRANSMITTER AND RECEIVER

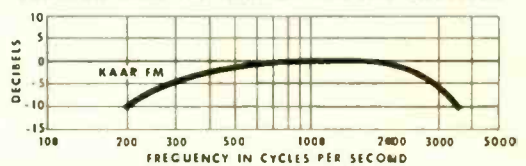

KAAR ENGINEERING CO.
PALO ALTO • CALIFORNIA



London Radiolocation Convention

Top-secret radar data is released in London by key men in war-time development laboratories

OLIVER PERRY FERRELL

KEYNOTE of the recent radiolocation convention in London appears to have been the interesting reflection by John Wilmot, minister of supply, speaking in behalf of the British government, that radio location which had accomplished so much in saving England from total destruction during the Battle of Britain was now in itself completely harmless and possessed no lethal powers.

The meeting, which was designed to cover at one sweep many of the heretofore secrets of radar and radiolocation, opened at 5:30 p.m. on Tuesday, March 26. After the introductory speeches by Dr. P. Dunsheath, President of the I. E. E., and Mr. Wilmot, Sir Robert Watson-Watt characterized the field of radiolocation as a tremendous engineering accomplishment. Sir Robert stated that the United Kingdom can be proud of the evolution of radar and that today there was no room for modesty where the members of the I. E. E. and the British I. R. E. were concerned. Over one-half of one percent of all the people in Britain were or have been during the war, connected directly with the development of radiolocation. Speaking from the production angle, over £1,000,000,000 were expended in the engineering services relating to this great project during the six war years. This apparently did not include the expenditures made in the defense of the Island since February, 1935. Sir Robert went on to define the terms radar and radiolocation and describe the real secret weapon of the war: the interplay of technical field experience and operational utility with laboratory theories and opinions.

Guest at the radiolocation convention and representing the United States was Dr. F. B. Llewellyn, president of the I. R. E. Dr. Llewellyn spoke in favor of the continued cooperation in peace that the development of radar had shown possible during the war. After a short description of the two American radars in use at the beginning of the war, the SCR 268 and SCR 270, Dr. Llewellyn reviewed the British mission in September of 1940, which, headed by Sir Henry Tizard took to the United States a magnetron seemingly capable of allowing the expansion of microwave radar. Before

the end of the war, American industry had fabricated a tremendous number of these magnetrons which were able to produce peak powers of approximately 3 megawatts at 3,000 mc.

Aerials for Radar Equipment

J. A. Ratcliffe

Representing a survey of the principles in antenna design which were employed during the war for radar equipment, this paper was directed as a foreword of the papers to follow. Mr. Ratcliffe opined that radiolocation antennas fall into two classifica-

tions: Those 'floodlighting' and those of a sharp horizontal directivity or 'beaming'. Directivity in a vertical plane has been difficult to obtain and is the present limiting factor in height-finding radars. However, with the trend to micro-waves, it is possible to produce beams so sharp that ground reflections can be largely eliminated. A short discussion of 'fan beams' and 'pencil beams', which are sharp in two planes at right angles, and polar diagrams was included. At the end of this talk, Dr. M. H. L. Pryce spoke a few words regarding the use of waveguides and the practice of employing their very low attenuation characteristics at centimeter wavelengths.

The Development of Ground Radiolocation Aerials

Dr. Denis Taylor

Dr. Taylor opened his talk by touching upon the much discussed multiplicity of



Keynoting the conversion of electronic weapons to peacetime pursuits, this is the first radar unit to be installed on a Great Lakes commercial ship, the John T. Hutchinson

Depend on **OHMITE** Experience FOR THE RIGHT RHEOSTAT CONTROL

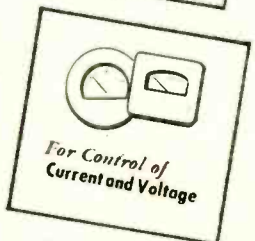
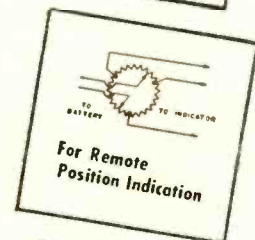
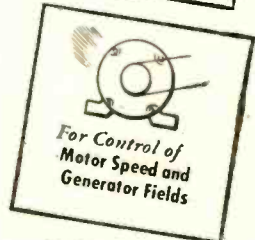
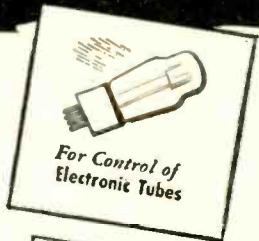

Time-proved Design! Widest Range of Sizes!

You get these advantages: (1) Ohmite experience with countless rheostat applications. (2) Service-proved Ohmite features that assure permanently smooth, close control. (3) Extensive range of sizes and types for easy, economical selection of the best unit for every application.

There are ten wattage sizes ranging from 25 to 1000 watts—from 1 $\frac{1}{16}$ " diameter to 12" diameter—in uniform or tapered winding—in single or tandem units—in regular or special designs. Stock models from 25 to 500 watts, in many resistance values.

Consult Ohmite engineers on your rheostat control problem.

OHMITE MANUFACTURING COMPANY

4868 FLOURNOY STREET, CHICAGO 44, U.S.A.



Send for Catalog
and Engineering
Manual No. 40

Write on company
letterhead for this
helpful guide in the
selection and applica-
tion of rheo-
stats, resistors, tap
switches, chokes
and attenuators.

Be Right with **OHMITE**

RHEOSTATS • RESISTORS • TAP SWITCHES • CHOKES • ATTENUATORS

design in radiolocation equipment. Explaining the necessity of coordination in operational requirements and technical practices, the evolution from the Yagi arrays to the carefully molded parabolic reflectors was fully covered.

Slot Aerials

Dr. H. G. Booker

At microwavelengths it has become practical to effect a very close relationship with the system of optics. In this manner, use has been made of Babinet's principles, where similar diffraction patterns are produced by two complementary antennas or screens, the opaque portions of one corresponding to the transparent portions of the other. From a theoretical viewpoint, the basic microwave aerial could consist of a resonant slot consisting of an infinite plane metal sheet, in which was cut a narrow straight slot one half wave long. The behavior of the slot may be likened to that of a complementary dipole consisting of the metal removed from the sheet. In practice it is possible to produce polar diagrams which in many respects are identical. A primary difference would be that the radiated wave polarization would be reversed, i.e., a horizontal slot emitting vertically polarized waves.

Slotted Linear Arrays

D. W. Fry

There are two main types of slots which were considered usable as linear radiators. Slots placed in positions where they normally draw no current were eventually discarded and slots cut in positions where they may intercept currents flowing in the walls of the wave guides are extensively employed. Slots that interrupted the longitudinal current down the broad faces of the guides are series-coupled. Those interrupting the storage current are shunt-coupled. The types used commonly in radiolocation devices are shunt-displaced slots in the broad face or shunt-inclined in the narrow face. Manufacture of shunt-displaced slots for wavelengths down to 3 cm has been possible, while shunt-inclined slots have been prepared at all wavelengths.

The Cheese Aerials

Dr. O. Bohm

The best antenna designed for the Royal Navy has been the so-called 'cheese aerial'. This has met strict naval requirements, as it is of excellent structural design and produces a fan-shaped horizontal beam. As the ship rolls, the antenna must assume the shape of a mirror broad in the horizontal plane and small in the vertical direction. To accomplish this, two parallel plates have been arranged to form a loss-free guide from the mouth of the wave guide to the reflector. As the reflector is a short section of a parabolic cylinder, the aerial was naturally a box, the aperture of which was a flat rectangle.

Wave Guide Matching Techniques

G. E. Wild

In considering the general problems of the impedance matching characteristics at the centimeter wavelengths it is apparent in radiolocation techniques that mismatches will arise at every section where the dimensions of the guide vary to any degree.

Each component part of the complete equipment must be exceptionally well matched to maintain tolerable standing wave ratios. Essentially, standing wave ratios become more important at microwaves than the term of characteristic impedance, since the latter is limited by the transverse dimensions. However, both properties eventually solve the entire matching problem.

Tropospheric Propagation

Dr. H. G. Booker

Wave refraction in the lower atmosphere has been known for years and often made it possible for radar receivers to 'see around corners' and locate aircraft flying effectively below the geometric horizon. Atmospheric ducts were created by specific meteorological conditions and act as natural wave guides. These ducts propagate the radar signal with the strength of the order of free-space variations. This effect was particularly prominent in the micro-wave field. In the vhf range the increase in wavelength became so great that ducts were unable to guide the wave effectively, and for long wavelengths in the radiolocation technique, atmospheric ducts are totally unknown. This super-refraction was essentially a good-weather phenomenon which tended to occur regularly in the warm temperate climates.

Measurement of the Refractive Index Gradient

Lt. Cdr. F. L. Westwater, R.N.

The determination of the varying refractive index gradients in the lower atmosphere has been carried out by the Royal British Navy. Three specially equipped ships with a new type of thermocouple recorders have correlated data with radar observations. Around the British Isles the distribution of humidity near sea level has been difficult to ascribe to known laws. The presence of exceedingly sharp discontinuities in both temperature and humidity has been found. The number and extent of observations have been limited and it will be necessary to measure the atmospheric structure at much greater heights than previously attempted.

Attenuation of Centimeter Radio Waves

J. W. Ryde

It has been found that the fair-weather signal attenuation is not excessive in the 3000 to 10,000 mc range. However, during heavy rain the attenuation of signal strength becomes a serious factor in working over long paths. With the development and increase in receiver sensitivity a certain amount of attenuation and echoes has been found even during moderate rain. In some instances a rain storm within ten to thirty kilometers will produce an echo comparable with that of an aircraft at the same range. This degree of signal attenuation and reflection is not apparent in the vhf band.

Microwave Propagation

Lt. B. S. Starnecki

While microwave signal strengths generally follow the quasi-optical theorem, certain peculiarities were observed when the path length was 60 miles or more. In one instance where the path length of the

radio link was 2.3 times the optical range, the signal strength was constantly much greater than predicted by diffraction-refraction formulae. A careful examination proved that between 50-70% of the increase in signal strength was due to super-refraction through atmospheric ducts 20 to 40 feet in altitude. In later experiments it was noted that only 15% of the excessive signal was through ducts over 50 feet in height.

Radar Received Field Strengths

J. M. Scott

It has been possible to successfully correlate the radar signal scattering powers of rain and shell bursts and reflection formulae. An example of the worthiness of this project was the determination of the order of radar echoes from the V-2 bomb some time before the first rocket was launched against the Island.

UHF Extra-Tropospheric Influences

Sir E. V. Appleton

There are two sporadic influences to be considered in radar operation. They are reflection of the pulse from the ionosphere and the interference of galaxy or solar static and noises. Transient bursts of ionization in the region of the E layer have been observed on VHF radar equipment. The development of microwave radar has removed this type of interference completely. Some very long range signal scattering by the F region was noted in certain climates. However, since this occurred at ranges up to 2,000 miles distant is of very little trouble and probably only of interest to the radiophysicist. Considerable knowledge has been gained in the search of minimum receiver noise levels, which at present appears to be limited by solar static or hiss. Other experiments have been carried out that confirmed the existence of some galactic static from the region of the Milky Way.

Development of Radio Valves

Dr. J. H. E. Griffiths

By 1939 and the beginning of the war a continuously-evacuated demountable type of valve for the CHL stations had been perfected capable of a 200 kw peak output, and oxide coated cathode types which permitted an output of 200 kw at 50 cm.

Cavity Magnetrons

J. T. Randall — H. A. H. Boot

The entirely enclosed resonant magnetron was put to test on February 21, 1940 and was an immediate success. Later, the problem of sealing was encountered, but before the American exchange trip, an 8 and a 14 resonator system had been developed for as low as 5 cm. The efficiency was between 10-20% depending upon the magnetic field.

Pulsed Magnetron

W. E. Willshaw — L. Rushforth

If an electron remains in the alternating field of an oscillating circuit for a number of periods of oscillation, the interchange of energy between the electron and the magnetic field during this time interval determines the efficiency of the magnetron.

[Continued on page 47]

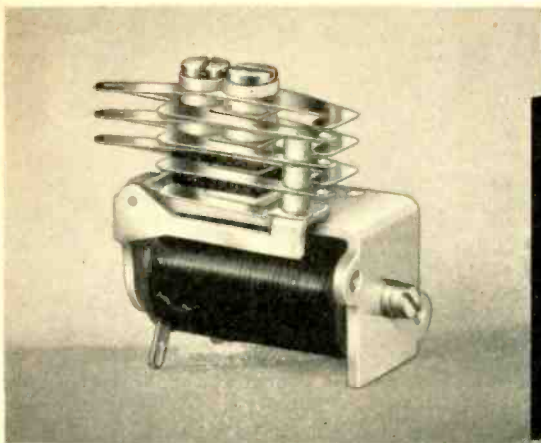

No. 400-452. Single pile up AEROTROL with combination Bakelite-Cecotite insulation for maximum insulation and low capacitance. Size $1\frac{1}{16}$ " x $2\frac{1}{32}$ " x $1\frac{1}{32}$ "; Weight 2 ounces. Operating voltage 14 volts D.C. Minimum operation .045 amperes. Coil resistance 280 ohms.

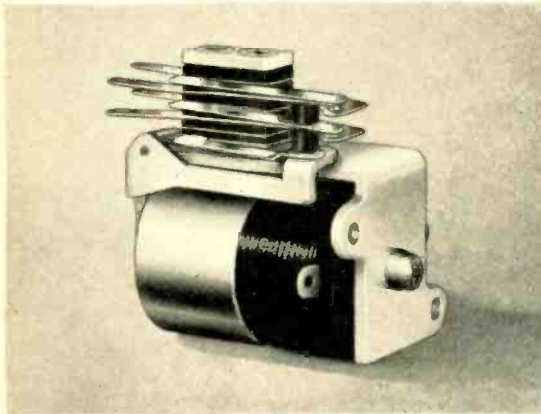

No. 400-494. Slow release AEROTROL for time-delay applications. Size $1\frac{1}{16}$ " x $2\frac{1}{32}$ " x $1\frac{3}{8}$ ". Weight 3.5 ounces. Operating voltage 24 volts D.C. Operating time 8 milliseconds. Release time 35 milliseconds. Minimum operation .085 amperes.

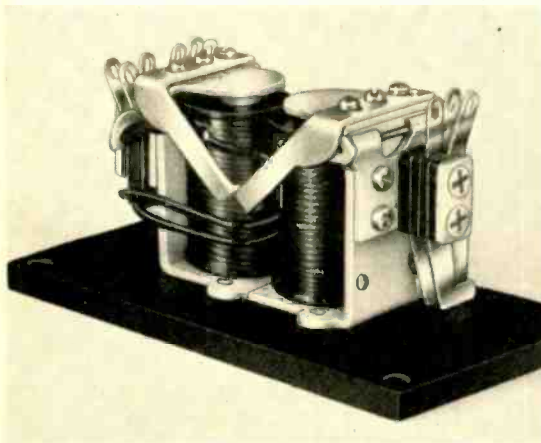

LATCHING AEROTROL showing special wiring between terminals. Any two AEROTROLS of similar or different types may be combined into a LATCHING AEROTROL while retaining the advantages of the individual relays. They offer a simple, yet positive, means of providing sequence operation of controlled circuits.

"AEROTROL" RELAYS FOR PRECISION PERFORMANCE

DESIGN ENGINEERS who demand the utmost in service from electronic components have long depended on Cook Relays. The Aerotrol "400" series form a complete line of small, compact, rigidly constructed relays for a variety of radio and electronic uses. In addition to the typical Aerotrols illustrated here, other types and sizes are available: single and double pile-ups, AC and DC operation, relays with special contact formations or with Cook Cecotite ceramic insulators, relays for heavy current or high frequency application, and many others. Complete engineering and production facilities under one roof and the highest standards of workmanship enable Aerotrols to meet the most exacting demands for precision performance. A letterhead request for Catalog R145 will bring complete details!

STRATOPAX your ELECTRONIC COMPONENTS



Above: STRATOPAXed units with (1) special mounting bracket and binding post terminals, (2) glass seal terminals, (3) Amphenol plug-in connection.

STRATOPAX Hermetic Sealing of components and assemblies in a special neutral atmosphere, a Cook wartime aircraft development, is now available to all industries. STRATOPAXing gives complete protection from weather, dust, moisture, arcing, explosion, corrosion and tampering. Improvement in performance is gained at a saving in cost because (1) specifications for corrosion-resistant materials, plating, etc., may be relaxed, and (2) the life of a unit is prolonged many times over. We invite your inquiries as to how Stratopax can improve your products.



CHICAGO 14, ILLINOIS

New Products

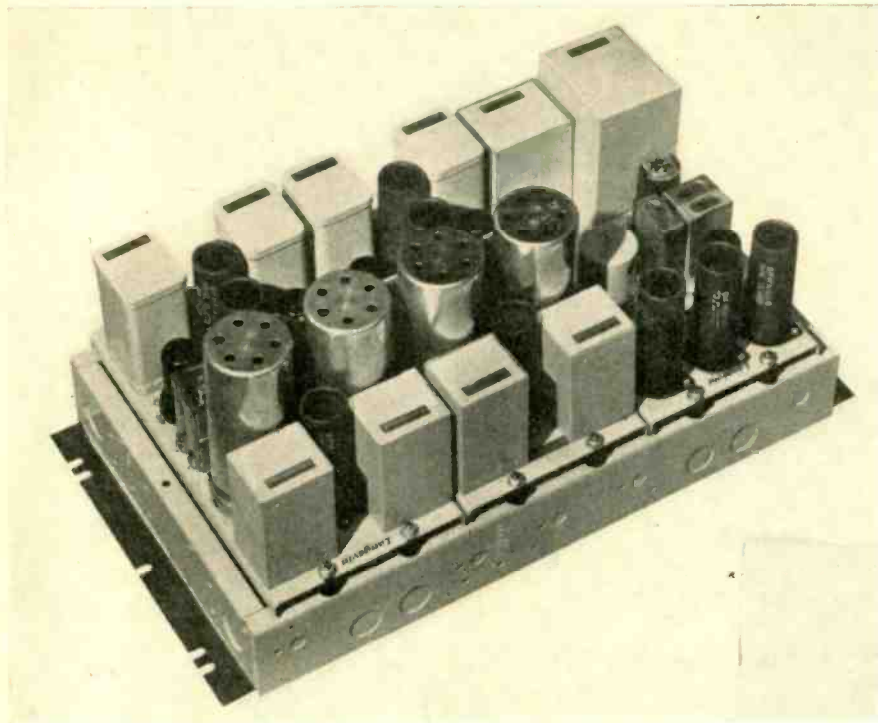

SPACE-SAVING AMPLIFIER

Lack of adequate space for amplifiers and associated equipment in studios and control rooms has become a rather serious problem. The new Langevin unit, designated as the Type 111-A, is a dual-channel, fixed medium gain pre-amplifier. It is designed for use in high-quality audio systems.

The accompanying illustration shows an arrangement of two of the Type 111-A pre-amplifiers and a single channel Type 102-A line amplifier, a total of four channels and a line amplifier, mounted on a Type 39-A mounting frame. This frame can be mounted in a wall cabinet, or on a standard relay rack.

For studio installations each microphone, or low level phonograph pick-up, is fed into a pre-amplifier. The output of the pre-amplifiers is then fed into a high-level mixing circuit, the output of which is fed into the line amplifier. This combination constitutes a high-quality audio system that meets the requirements of recording, public address and studio input engineers.

Each channel of the Type 111-A amplifier operates from a source impedance of 30, 50 or 600 ohms into a load impedance of 600 ohms. The output power is 0.038 watt (± 16 VU), with less than 1% total harmonic distortion at 400 cycles. Production run characteristics ± 0.5 to 1 db over the range of 30/15,000 cycles.

An external source of power supply is required, as follows: filaments, 6.3 volts, 1.2 amperes; plate, 275 volts, 16 milliamperes.

Manufactured by the Langevin Company, Inc., 37 West 65th Street, New York 23, N. Y.

GAS SWITCHING TUBES

Gas switching tubes designed to provide efficient, high-speed, automatic transmitter-receiver service in super-high frequency



waveguides in radar and pulse time communication systems in the 8490-9600 mc range have been developed by the electronics division of Sylvania Electric Products, Inc., 500 Fifth Avenue, New York 18, N. Y.

Good electrical contacts result from mounting the bottom of the tube flush with the inside of the main guide and four-point pressure contact on a rectangular ring gasket 0.030" between the top of the tube and the far end of the branch. Anti-TR tubes, type 1B37 with a range of 8490 to 9000 mc. and type 1B35 with a range of 9000 to 9600 mc. are designed for use with type 1B24 TR tube with a tuning range between 8490 and 8600 megacycles in all conventional applications within this frequency range.

PROGRAM TIME SWITCH

New simplified automatic control of radio and recorded programs has been perfected by Zenith Electric Company, 152 W. Walton St., Chicago 10, Illinois. The unit is now available to the market.

This control is embodied in a program time switch Type PR-24, which operates

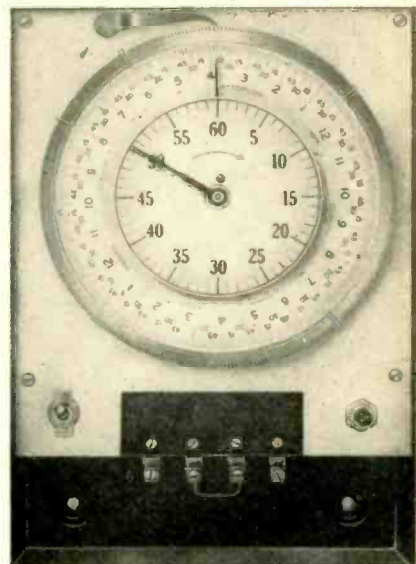

automatically to periods as close as five minutes throughout the twenty-four hours, or any part thereof. It repeats daily, requiring no further attention than the setting. Changes in the setting are easily and quickly made without tools.

MULTIMETER

This new instrument, Model 203, is designed to perform more functions than most volt-ohm-milliammeters. It measures wide ranges of capacity, resistance, a-c



and d-c current and voltage. Inductance measurements are also possible.

A high input impedance minimizes loading when making voltage measurements. Its electronic ohmmeter circuit permits measurements from 1.0 ohm to 10,000 megohms. Its capacity measuring circuit utilizes low voltage for measurements.

For further data, write the Hickok Electrical Instrument Co., 10532 Dupont Ave., Cleveland 8, Ohio.

[Continued on page 32]



Model A-81 Cabinet

Model A-121 Cabinet

Model A-151 Cabinet

THE FAMOUS

** Bass Reflex*

REPRODUCERS IN NEW,
BETTER-THAN-EVER DESIGNS

True high-fidelity reproducers with the famous and exclusive *Jensen Bass Reflex* principle of design are now available in improved postwar cabinets. *Jensen Bass Reflex* reproducers give crisp, extended range reproduction . . . no back-side radiation . . . full bass with no boom.

Bass Reflex Reproducers are widely used in broadcast monitoring and in recording work. They are ideal for ham shack use and are in much demand for phonographs, FM reception, and general sound reinforcement applications.

Jensen Bass Reflex Reproducers are available in sizes for 8-inch, 12-inch and 15-inch loud speakers and are designed for floor or wall installation. The 15-inch cabinet is designed for both Type J and Type H *Jensen Coaxial Speakers* and for single-radiator 15-inch speakers.

Write for complete literature.

* Trade Mark Registered

 **Jensen**
SPEAKERS
WITH **ALNICO 5**

JENSEN RADIO MANUFACTURING COMPANY
6615 SOUTH LARAMIE AVENUE • CHICAGO 38, ILLINOIS
In Canada: Copper Wire Products, Ltd., 137 Oxford Street, Guelph, Ontario

The Jensen exhibit will be in Booth 68 at the 1946 Radio Parts Show in Chicago's Stevens Hotel, May 13th through 15th. Old and new friends alike are cordially invited to see the 1946 line of Jensen fine acoustic equipment.

Specialists in Design and Manufacture of Fine Acoustic Equipment

ANTENNA KIT

An antenna kit for communications, broadcast and short wave receivers is announced by Vertron Corp., 60 E. 42nd Street, New York 17, N. Y. The antenna,

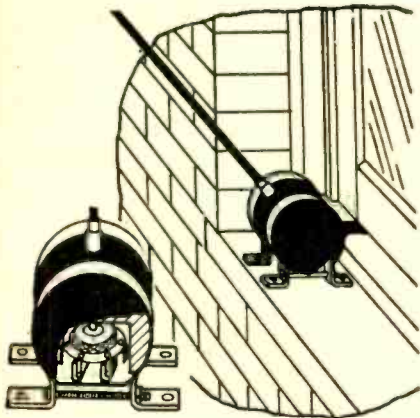

Model 103, consists of a 3-section, 9-foot hard aluminum mast mounted on a patented rotary base. Base rotates easily in two mounting brackets in an arc of 180 deg. This permits aerial to be mounted erect on any surface having 4 inches of space for the base. Inside base is an hermetically sealed transformer to match the impedance of the rod to the transmission cable (see cut). The radio set coupler, another transformer sealed in a plastic shell, matches the impedance of the transmission cable to that of the radio receiver input. This forms a completely balanced transmission system capable of piping r-f signals, 500 kc to 30 mc. "No poles, no insulators, no climbing, no hanging aerial wires," is the way the manufacturer sums up this product. Shipping weight 5 lbs.

COMPOUND TANK

A new gas fired, electrically controlled, fully insulated, production tank for heating, melting and pouring battery transformer, capacitor and resistor compounds has been announced by Aeroil Products Company, West New York, New Jersey.

This new unit is heated from the inside through a patented removable immersion tube system. This new method of heating plus full insulation brings the user a saving of 50% in time, labor and fuel it is claimed by the manufacturer.

The novel feature of this new unit is that it is equipped with two outlet valves that are separately heated. Since each outlet valve is at opposite ends of the tank



this means that the two operators can work independently with both hands of both workers free (see illustration above). The distance across the table between the valves is 21" leaving plenty of room to set up cooling racks or other production aids. The ends of the valve are 15" above the table level thus giving plenty of clear working space.

LOW CURRENT RELAY

Designed and built by the instrument division of Thomas A. Edison, Inc. of West Orange, N. J., for aircraft use, this sensitive magnetic relay Model 103 is now available for use in the electronic and industrial fields where relays are required for operation on currents of thermocouple and photocell magnitudes and in equipment where compactness, light weight, and dependability under vibration, are of primary importance.

It is particularly useful as a polarized relay in vacuum tube circuits, in balanced

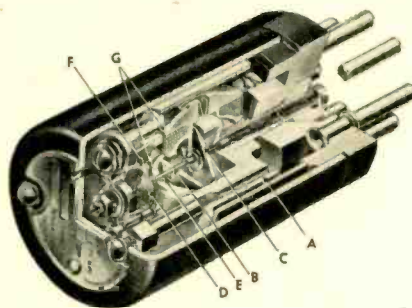

circuits, and in applications requiring pull-in and drop-out at essentially the same current or voltage. In extremely delicate control circuits, this relay can be used to help "shrink" mechanical design by eliminating intermediate amplification. The entire mechanism is protected against weather and dust by a gasketed metal cover and it is balanced to allow operation in any position.

TELEVISION CAPACITORS

A new line of small, light-weight capacitors designed to meet the requirements in size and weight imposed by the compact design of modern television receivers has been announced by the General Electric Company.

Developed especially for use in smoothing out the high-voltage power supply in this and similar applications, these new Lectrofilm units are equipped with prong-type terminals which meet the special mounting requirements of television receiver applications.

Currently available in two designs, a flat cylinder and a tubular construction, these units are rated 0.005 μ f, 4,000 to 16,000 volts.

Bulletin GEA-4558, available on request to the company at Schenectady, N. Y., contains detailed information on the new capacitors.

'SQUARE WAYER'

Maguire Industries announce their 'square wayer,' which converts the output of audio sine wave generators to square waves. Technical specifications are: Frequency range, 2 to 200,000 cps; impedance, 75,000 ohms; voltage, 6 to 150 volts; fre-



quency range, 20 to 20,000 cps with waveform square to 1% (2 to 200,000 cps total response); rise time, 1 microsecond to 99% of maximum amplitude; voltage, 15 volts maximum peak-to-peak open circuit with continuously variable attenuation from 0 to 60 db.

Tubes used are one 5Y3GT, two 6V6GT, one 6H6GT, one 6SH7.

NEW SWITCH

General Control Co., 1200 Soldiers Field Road, Boston 34, Mass., announces the new Model MCF, a 5-position cam-lever switch, designed especially for ease in assembly and wiring. The two features which provide this are single hole mounting of the switch frame to the panel and single bolt assembly of the contact block to the switch frame.

The silver contacts are permanently riveted to nickel-plated, phosphor-bronze

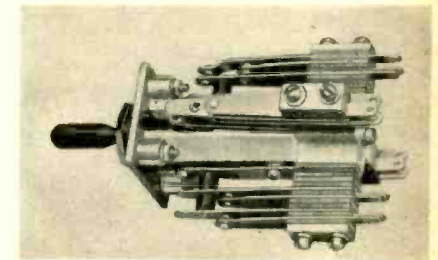

contact springs, and all parts are non-corrosive to assure long life. The contacts are rated at 10 amperes, 125 volts, a.c. (non-inductive load).

COIL WINDING MACHINE

An improved coil winding machine is announced by Connecticut Specialties Co., Box 501, Stamford, Conn. This multiple winding machine is a light compact unit. Quick adjustment and versatility are featured.

Winding capacity is 2000 coils per day, in wire sizes ranges from 20 to 44. Coil capacity ranges from the smallest to 6". The only electrical component of the multiple coil winder is a 1/3 h.p. motor, with 800 to 2500 RPM.

NEW C-R TUBE

Greater brilliance and deflection sensitivity characterize the new Du Mont Type 3JP cathode-ray tube just released by Allen B. Du Mont Laboratories, Inc., of Passaic, N. J. This type is the logical successor to the wartime Types 3BP and 3FP.

The 3JP is designed for oscillographic and other applications requiring a small, short tube with very high light output and deflection sensitivity. It is an excellent

[Continued on page 40]

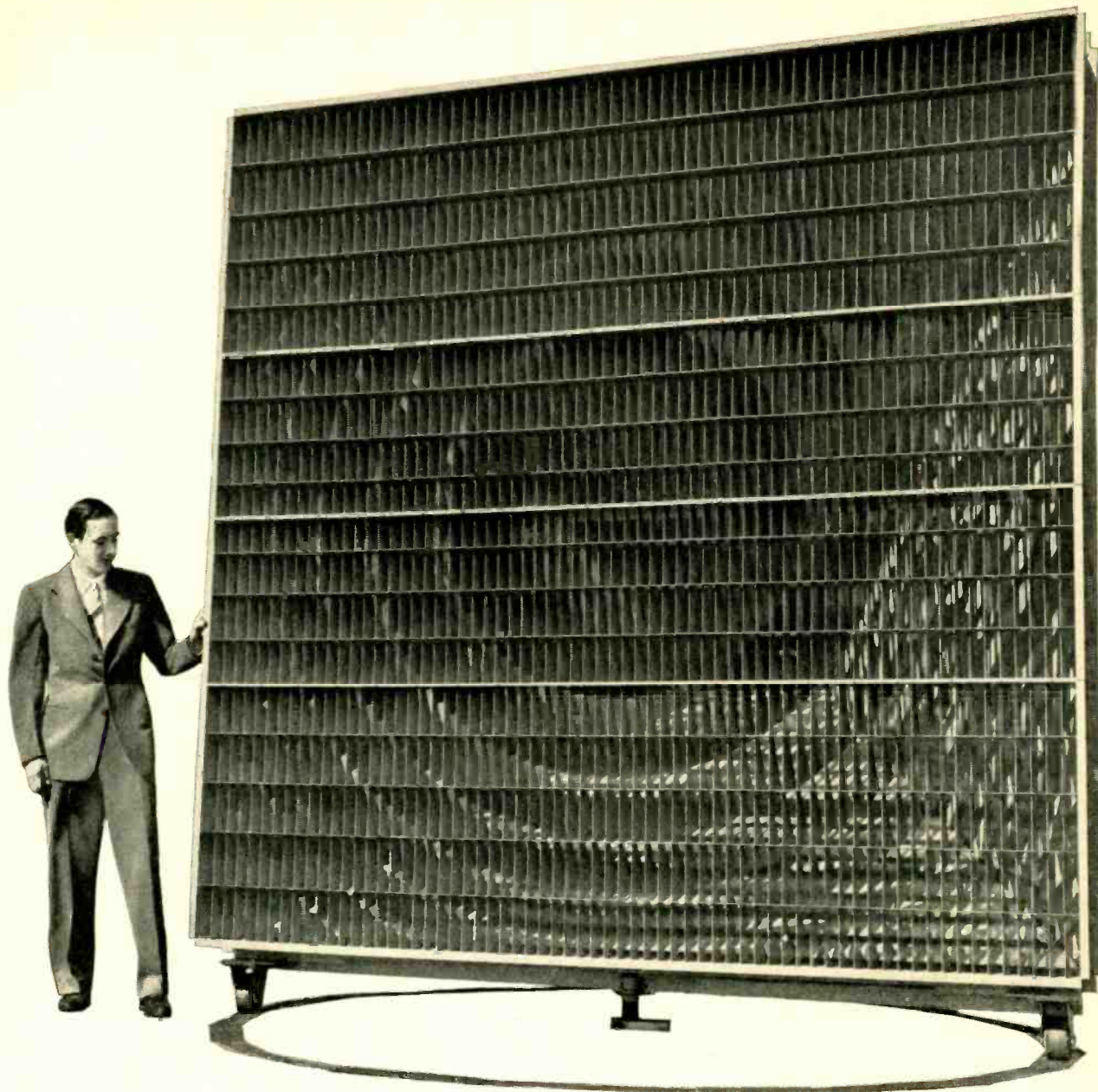

A "SEARCHLIGHT" TO FOCUS RADIO WAVES

In the new microwave radio relay system between New York and Boston, which Bell Laboratories are developing for the Bell System, giant lenses will shape and aim the wave energy as a searchlight aims a light beam.

This unique lens—an array of metal plates—receives divergent waves through a waveguide in the rear. As they pass between the metal plates their direction of motion is bent in-

ward so that the energy travels out as a nearly parallel beam. At the next relay point a similar combination of lens and waveguide, working in reverse, funnels the energy back into a repeater for amplification and retransmission.

A product of fundamental research on waveguides, metallic lenses were first developed by the Laboratories during the war to produce precise radio beams.

This "searchlight" is a milestone in many months of inquiry through the realms of physics, mathematics and electronics. But how to focus waves is only one of many problems that Bell Telephone Laboratories are working on to speed microwave transmission. The goal of this and all Bell Laboratories research is the same—to keep on making American telephone service better and better.



BELL TELEPHONE LABORATORIES

EXPLORING AND INVENTING, DEVISING AND PERFECTING FOR CONTINUED IMPROVEMENTS AND ECONOMIES IN TELEPHONE SERVICE

RADIO

★ MAY, 1946

33

This Month

NEW FACSIMILE UNITS DEMONSTRATED

Regarding the impact on the publishing field of new electronic developments such as FM and Facsimile, Capt. W. G. H. Finch, president of Finch Telecommunications, Inc.; developers and manufacturers of facsimile equipment told members at the American Newspaper Publishers convention, meeting at the Waldorf-Astoria in New York, that now is the time for publishers to get in on the ground floor of facsimile, thus protecting themselves against the time when this new method of broadcasting achieves mass audience. "Facsimile is a natural for newspapers", he said, "as an eventual supplement to newspapers," and said that today's newspaper publishers are best qualified to develop this new field.

Captain Finch, who owns the new recently completed FM-facsimile station WGHF in New York operating on 99.7 megacycles, then demonstrated to the members the radio transmission and reception of a 4 page newspaper transmitted from the WGHF station at 10 East 40th Street in New York to the floor of the convention meet.

The four page illustrated paper called "Airpress", each page 8½ x 11 inches long took eight minutes to run off. The high-speed high-definition facsimile home unit produced the copy at a speed of 44 sq. inches of picture copy of 550 words per minute using 8 pt type.



(Above) Finch facsimile unit produces high-definition copy at the rate of 550 wpm; picture copy is recorded at a speed of 44 square inches per minute. (Below) Virginia Gorram looks on as Radio Inventions President John V. L. Hogan explains latest Faximile home recorder; the unit prints by radio in set owner's home everything that can be printed in a daily newspaper including photographs, text, cartoons and advertisements.



During the meeting Capt. Finch disclosed that the first FM broadcasters to receive improved post-war facsimile apparatus include the following stations: WMGM, New York-FM affiliate of station WHN; KMGH, Los Angeles, California, both MGM interests stations; KJBS, San Francisco, Cal.; San Bernardino Broadcasting station at San Bernardino, Cal.; the Western Reserve Broadcasting Co., Cleveland, Ohio and the newspaper-owned station WJJD in Chicago, Ill., (the Chicago Daily Sun).

Facsimile is predicted to have a significant future in police and railroad communication, for interplant and interoffice use, in mining, forest fire control, for transmission of non-alphabet languages, in aviation, department stores, shipping offices, and fire department interoffice communication.

Hogan Faximile

Newly designed facsimile equipment which prints four 9½x12-inch pages of text or photographs in the home by radio during a fifteen-minute broadcast period was demonstrated by John V. L. Hogan, president of Radio Inventions, Inc.

Chairman Charles R. Denny of the FCC, together with Commissioners Jett, Walker, and Hyde, and a number of the com-

The Answer to Television and
Other High-Voltage Resistor
Applications...



Completely insulated surface

Standard Sprague Koolohm Wire Wound Resistors have the high insulation resistance to ground which you need for television and other applications where high voltages are involved—10,000 volts from the surface of their sturdy ceramic jackets to their resistance elements. Mount them anywhere without fear of voltage breakdown!

In addition, Koolohms give you the advantages of higher resistances in smaller physical sizes; easier mounting; use at full wattage ratings; and overall tropicalized protection against the most severely humid conditions. Write for Catalog 10EA.



SPRAGUE ELECTRIC CO., Resistor Division, North Adams, Mass.

SPRAGUE KOOLOHMS

TRADEMARK REGISTERED U.S. PAT. OFF.

The Greatest Wire-Wound Resistor Development in 20 Years

mission staff members inspected the operation of the new system. It is reported that commissioners felt encouraging progress had been made.

The Faximile recorder which prints in the radio set owner's home is a little larger than a portable typewriter. Printed pages emerge from a slot in the top surface of the set at a rate of 28 square inches per minute, a transparent window enables the owner to see the page as it is being recorded.

MYCALEX

A new 24-page booklet on G-E mycalex, a stone-like product composed of mica and a special glass, has been published by the chemical department of the General Electric Co.

Describing in detail both the technical and manufacturing data compiled by General Electric in its 23 years of mycalex production, this illustrated bulletin lists the properties, available types, molded parts, fabricated parts, machining practice and how and where to order the material. An important feature is a properties chart of six grades of mycalex of both the compression and injection molded types.

The various features of the material such as dielectric qualities, arc and heat resistance, mechanical strength, water absorption, moldability and machinability are compared with the same properties of cold-molded refractory materials, hot-molded phenolics, wet-process porcelain, steatite and fused quartz.

The design section of the booklet explains the size range, thicknesses, undercuts, taper, radii, holes and inserts that are practicable in molding mycalex parts; preferred shapes, tapped holes, counter-boring, thickness of flat parts, round rods, corners, angles, holes, bushings, slotted bars and tolerances of fabricated parts; and

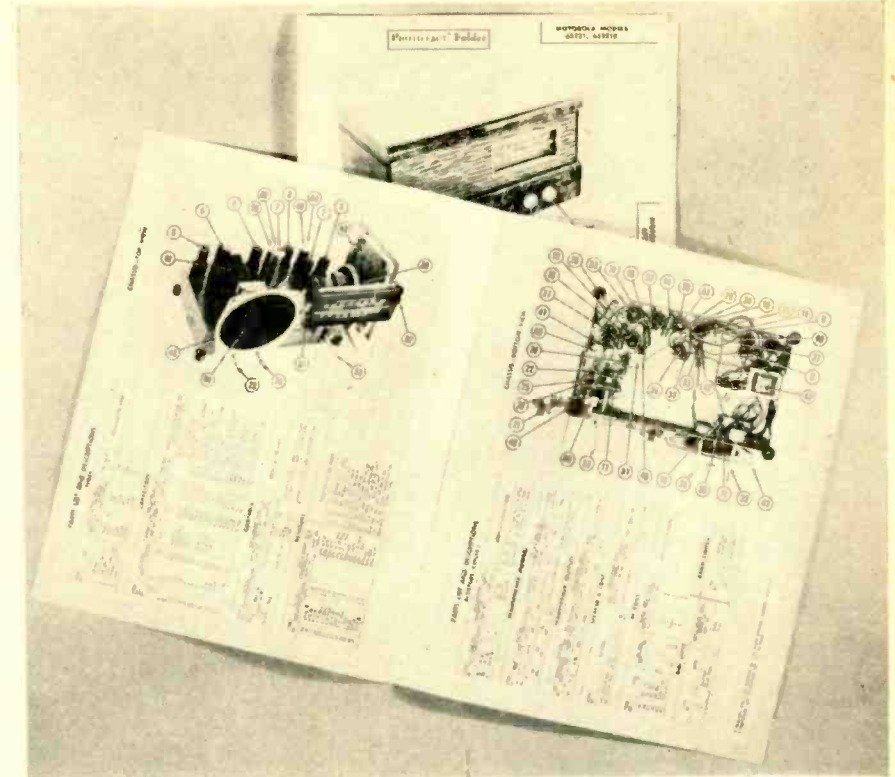

Howard W. Sams & Co., Inc., Indianapolis, Ind., is producing "PhotoFact" folders like the one illustrated, to cover all servicing details of radio receiver models manufactured after Jan. 1, 1946. The folders contain from four to 12 pages of service and photos, depending on the requirements of the set involved.

cutting, drilling, tapping holes, punching, milling and grinding of machined parts.

General Electric states that G-E mycalex is used where stability at high-operating temperatures, widely changing atmospheric conditions, together with inherently high-arc resistance, high electrical and mechanical strength and low-dielectric power loss are primary considerations.

PACKAGE B-C

Conlan Electric Corp. announces that it will provide AM, FM and television studios and stations as a package item. These services are offered through its design and engineering division.

Their service includes design of complete F-M and A-M Radio and television studios and stations: antenna structures, equipment layouts, construction drawings, studio styling, power and lighting systems, etc. In conjunction with their installation department they will prepare contract bids for, and effect complete installations of studios and stations, as well as assisting through their Washington affiliates in obtaining F.C.C. approval of station applications.

Ira Kamen, formerly supervisory engineer (professional grade) of the field section, Navy yard, New York, chief engineer of hearing aid laboratories, Herald Electric Co., is chief electronics engineer of the Conlan Electric Corp.

CATHODE-RAY FACSIMILE PATENT

Issuance of a patent, Number 2,394,435, dated February 5th, 1946, to Captain William G. H. Finch covering a cathode-ray facsimile receiver has been announced by the Commissioner of Patents.

The patent describes a principle for using the effects of a magic eye in facsimile recording at high speeds. The development of the cathode ray tube has been a subject of intense interest in the laboratories of Finch Telecommunications, Inc.

From the early beginning, now embodied in Patents Nos. 2,082,692, 2,095,929, 2,097,392, the laboratories of the Finch

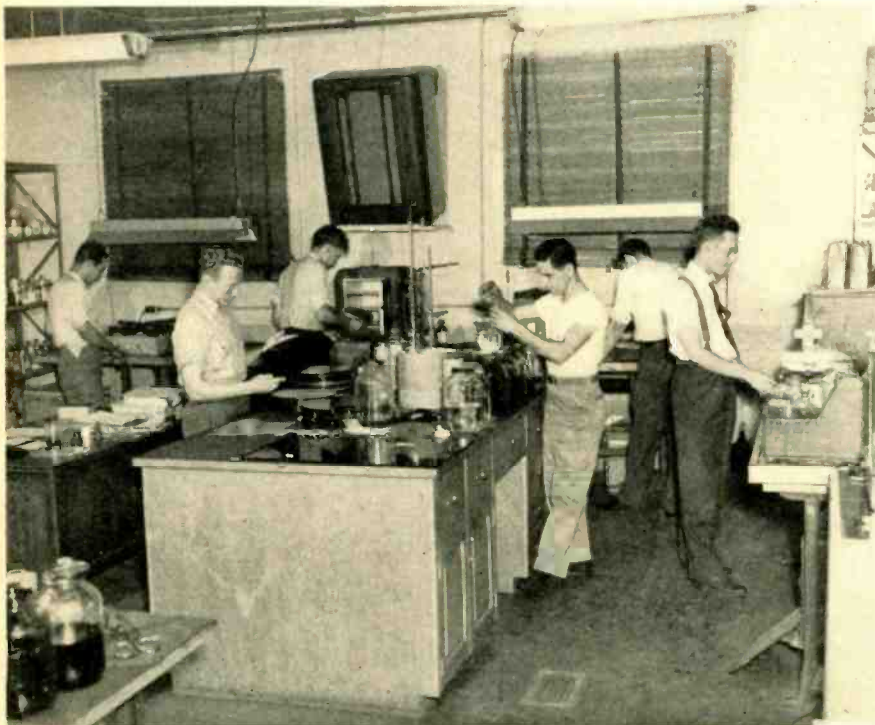

Audio Devices, Inc., has opened new laboratories at Stamford, Conn., devoted exclusively to sound recording and research. Pilot models are tested for performance, and recordings are analyzed for tone distortion, surface noise, and wearing qualities.

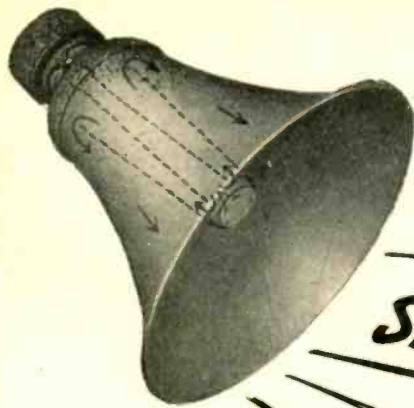

RACON

SPEAKS FOR ITSELF

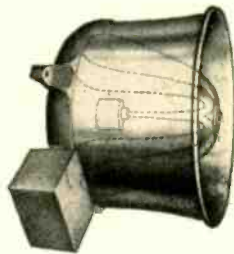

MARINE SPEAKER: approved by the U. S. Coast Guard, for all emergency loud-speaker systems on ships. Re-entrant type horn. Models up to 100 watts. May be used as both speaker and microphone.

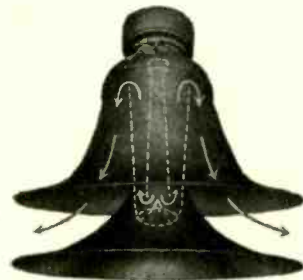

RADIAL HORN SPEAKER: a 3½' re-entrant type horn. Projects sound over 360° area. Storm-proof. Made of RACON Acoustic Material to prevent resonant effects.

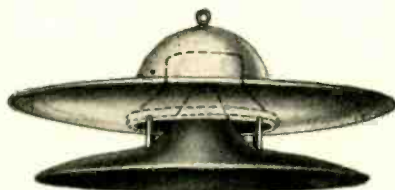

RADIAL CONE SPEAKER: projects sound over 360° area. Cone speaker driven. Will blend with ceiling architecture. RACON Acoustic Material prevents resonant effects.



AEROPLANE HORNS: super-powerful and efficient P.A. horns for extreme range projection. 9-4-2 single unit trumpets available.

Indoor — outdoor or on shipboard — RACON SPEAKERS, HORNS, and DRIVING UNITS are designed for every conceivable application.

Racon's precision manufacture assures maximum efficiency and high fidelity "true-tone" reproduction even at full power output. All-weather construction design makes Racon speakers impervious to any climatic condition, prevents resonant effects, assuring long, rugged, trouble-free service. Specify and use RACON! All types now available. Write us your requirements now — get our new catalog.

RACON

RACON ELECTRIC CO.

52 EAST 19th ST. NEW YORK, N. Y.

Company, directed by Captain William G. H. Finch, have conducted research in the use of cathode ray tubes in facsimile for instantaneous recording employing the principles of the recently issued patent, and others which are covered in further pending patent applications. These permit the advantage of instantaneous reception of television systems to be combined with the benefits of facsimile recording.

Particular emphasis has been based on synchronizing and phasing to ensure clear and sharply defined pictures in construction which the company engineers believe will be less expensive and more positive in its operation than the present more complicated mechanical facsimile systems.

In this development, Captain Finch has been able to make use of increased knowledge acquired during the war in the de-

sign, construction, operation and use of cathode ray tubes. During the war, Captain Finch headed up the research and design activities of the Countermeasures section, electronics division of the Bureau of Ships, U. S. Navy.

Personal Mention

Neal Turner

★ Neal Turner, former engineering sales manager for the RFC project in the Clearing, Ill., plant of the Hallicrafters Company, producers of high frequency radio equipment, has been elevated to the position of quality control chief at Hallicrafters, according to an announcement made recently by William J. Halligan, president of the firm.

In his new position, Turner will assume charge of line inspection, set and maintain standards for units, and be in charge of final tests and test equipment, in addition to inspection of incoming material.

Previously, he had served as a civilian employee with the Signal Corps, helping to set up repair depots in France and Belgium after V-E Day for equipment destined for shipment to Pacific areas. He was instrumental in setting up a plant near Paris in which the famous SCR-299's, mobile communications units made by Hallicrafters, were repaired after being damaged in battle.

Prior to his overseas work, he had been an inspector for Signal Corps equipment for both Hallicrafters and the Galvin Manufacturing Company, and was co-ordinator for the SCR-299. Earlier, he had designed, maintained, and operated police radios for five years in Macon, Ill.

Walter R. Jones

★ Walter R. Jones, a 17-year associate with Sylvania Electric Products Inc., has been appointed chief engineer of Sylvania's radio tube division, it was announced by H. Ward Zimmer, vice president.

Formerly general engineering manager for radio tubes and manager of the commercial engineering department. Mr. Jones is a senior member of IRE and the Fellow Radio Club of America. He received his electrical engineering degree from Cornell University.

Ralph A. Hackbush

★ Ralph A. Hackbusch, vice-president and managing director of the Stromberg-Carlson Company Limited, Toronto, Ont., has been elected a director of the Institute of Radio Engineers to serve during the year 1946.

Mr. Hackbusch was made an associate of the IRE in 1926, a member in 1930, and a fellow in 1937. Mr. Hackbusch has also served as chairman of the Toronto section of the IRE, was a member of the board of directors in 1938, and a committee member of the IRE board of admissions and public relations in 1940.

Dr. Noel C. Jamison

★ Dr. O. S. Duffendack, President of Philips Laboratories, Inc., recently organized research center for all Philips interests in the United States, has announced the following addition to his staff at Irvington, N. Y.:

Dr. Noel C. Jamison, research physicist, has joined Philips as division chief in charge of electro-acoustics. He received his B.A. degree at Bradley Polytechnic Institute in 1925 and his Ph.D. degree at Northwestern University in 1931. Dr. Jamison also attended the Universities of Goettingen and Hamburg in Germany for special courses.

Dr. Jamison was assistant professor of physics at Northwestern University until 1941 and then went to Harvard University to work on an important secret project under the auspices of the National Defense Research Committee. He is a member of the American Physical Society and of Sigma Xi Society.

Ingenious New Technical Methods

To Help You with Your Reconversion Problems



New Portable Grinder Lasts Longer ... Increases Production

The Portable Gaston Grinder is designed for the grinding and sanding of metal—also, with wire brushes, for paint and rust removal. Because it is powered by a 3-phase motor, without brushes, commutators or gears, the Gaston will give long service.

The Gaston Grinder starts at full speed. Its speed remains constant regardless of extra pressure by the operator. This controlled speed under heavy load, eliminates glazing of the grinding wheel; produces a better ground surface.

Three sizes of dust-tight Gaston Grinders are available. Furnished in either "cup-wheel" or "edge-wheel" type, as desired.

In a dusty work atmosphere, that causes throat irritation and dryness, chewing Wrigley's Spearmint Gum helps keep workers' mouths moist and fresh—thereby reducing work interruptions—and "time out" to the drinking fountain.

Workers can stay at their machine, while chewing Wrigley's Spearmint—even when their hands are busy. There is no lost time. And the pleasant chewing helps keep them alert and wide-awake. One Connecticut manufacturer with a dust problem reports group production up about 3% over normal, when workers were given chewing gum. Other plants and factories everywhere, claim stepped-up efficiency when chewing gum is made available to all.

You can get complete information from William H. Howland
2533 East 73rd Street, Chicago 49, Illinois

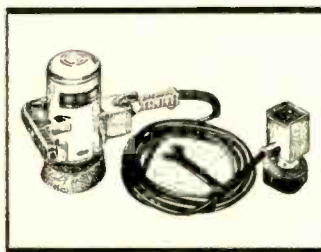

The Portable Gaston Grinder



AA-68

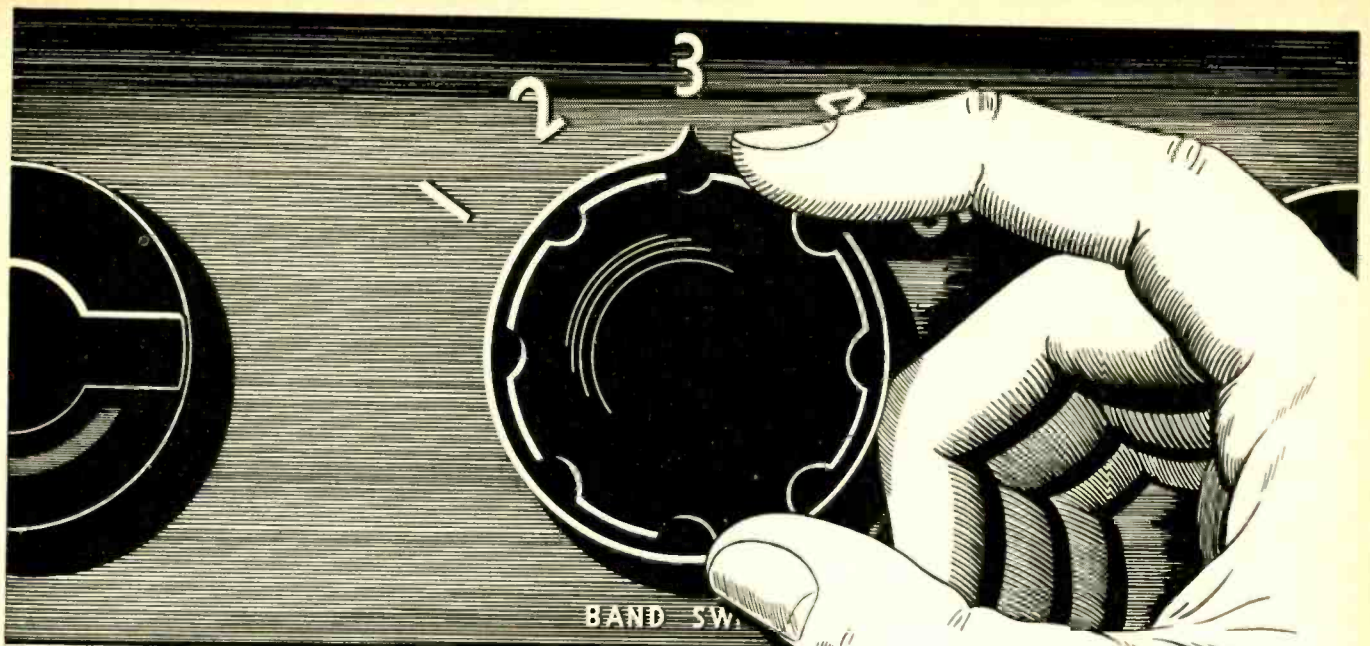

For easier bandswitching use the 257B Gammatron!

The HK-257B beam pentode, originated by Heintz and Kaufman engineers, facilitates the design, construction, and operation of multi-band transmitters since it requires very little driving power and no neutralization.

The wiring diagram below shows a transmitter capable of operating on all amateur bands from 10 to 160 meters. A single 6V6 metal tube in the oscillator circuit drives the r.f. amplifier to its full output. The precise internal shielding of the HK-257B makes neutralization unnecessary.

Write today for complete data on the 257B Gammatron, a versatile tube capable of very high frequency operation.



HEINTZ AND KAUFMAN LTD.

SOUTH SAN FRANCISCO • CALIFORNIA



Export Agents: M. Simon and Son Co., Inc.
25 Warren Street • New York City

KEEP IT UP...BUY WAR BONDS

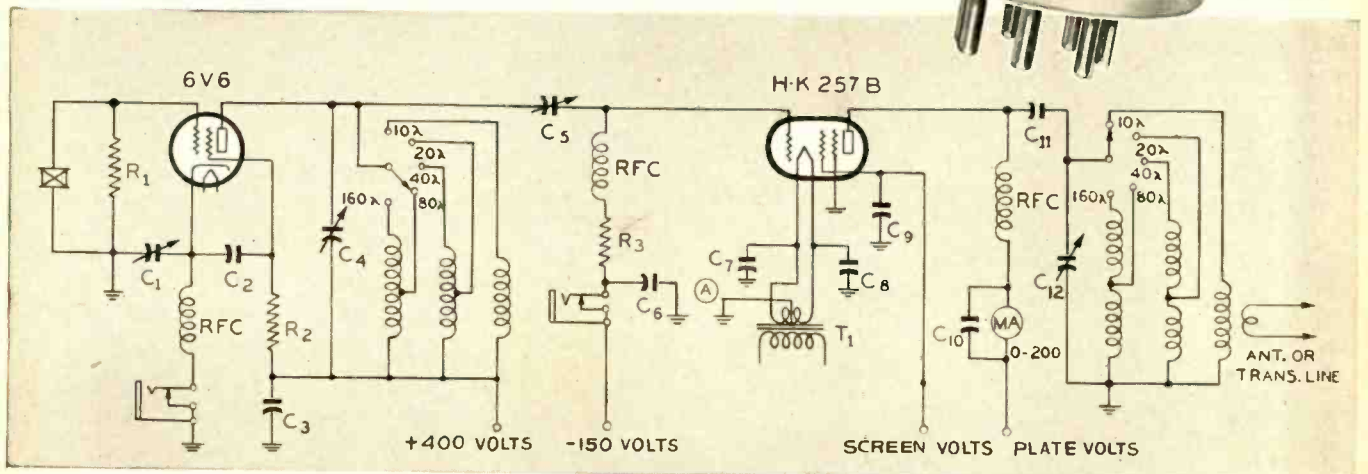

ATTENUATORS by TECH LABS



MIDGET
TYPE
600

"Midget" model is especially designed for crowded apparatus, or portable equipment.



STANDARD
TYPE
700

- Solid silver contacts and stainless silver alloy wiper arms.
- Rotor hub pinned to shaft prevents unauthorized tampering and keeps wiper arms in perfect adjustment.
- Can be furnished in any practical impedance and db. loss per step upon request.
- TECH LABS can furnish a unit for every purpose.
- Write for bulletin No. 431.



Manufacturers of Precision Electrical Resistance Instruments
337 CENTRAL AVE. • JERSEY CITY 7, N. J.

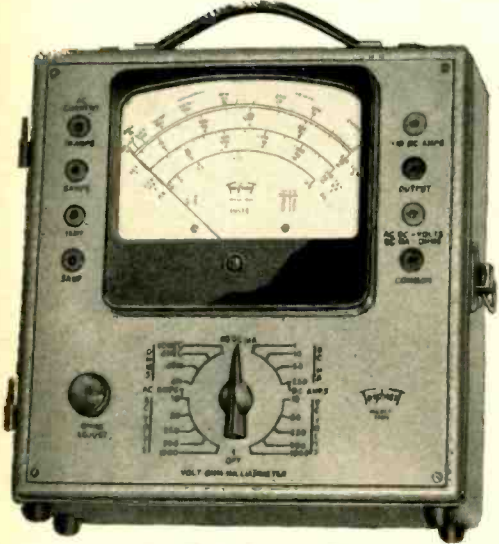

MODEL 2405

Volt • Ohm Milliammeter

25,000 OHMS PER VOLT D. C.



SPECIFICATIONS

- NEW "SQUARE LINE" metal case, attractive tan "hammered" baked-on enamel, brown trim.
- PLUG-IN RECTIFIER — replacement in case of overloading is as simple as changing radio tube.
 - READABILITY—the most readable of all Volt-Ohm-Milliammeter scales—5.6 inches long at top arc.

Model 2400 is similar but has D. C. volts Ranges at 5000 ohms per volt.
Write for complete description

Triplet

ELECTRICAL INSTRUMENT CO.
BLUFFTON OHIO

- NEW ENGINEERING
NEW DESIGN • NEW RANGES
30 RANGES**
- Voltage: 5 D.C. 0-10-50-250-500-1000 at 25000 ohms per volt.
5 A.C. 0-10-50-250-500-1000 at 1000 ohms per volt.
- Current: 4 A.C. 0-.5-1-5-10 amp.
6 D.C. 0-50 microamperes—
0-1-10-50-250 milliamperes—
0-10 amperes.
- 4 Resistance 0-4000-40,000 ohms—4-40 megohms
- 6 Decibel -10 to +15, +29, +43, +49, +55
- Output Condenser in series with A.C. volt ranges

NEW PRODUCTS

[from page 32]



tube for equipment which must be operated under extremely strong ambient light conditions. The focusing electrode current under operating conditions is negligible, thereby simplifying bleeder design. The 2" neck and diheptal base provide adequate insulation between electrode leads for high-altitude installation.

AUTO ANTENNAS

A new line of radio antennas for all types of mounting in motor vehicles has been announced by the specialty division of General Electric Company's electronics department at Syracuse.

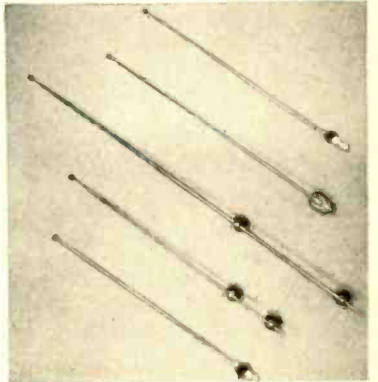

Designed for every type of installation and available in sizes ranging from 56 to 100 inches, the new antennas eliminate electrical interference by the use of radar-type shielded leads and connections. Angular adjustment and the quickly connected, detachable leads—ferrule tipped with bayonet adaptor—will aid the flexibility and ease of installations of the new antennas.

NEW TRIODE

Machlett Laboratories, Inc., Springdale, Conn., announce a new high-frequency, water-cooled triode, featuring the use of heavy sections of Kovar for the glass seals. According to Machlett engineers, the tube finds use up to 50 mc at full power input.

NEW TV TUBE

A new type 3-150A multi-element triode is announced by Eitel-McCullough, Inc., San Bruno, California. The characteristics of this new vacuum tube make it suitable for many applications, including television and industrial heating. The 3-150A incorporates a new design plate and a non-

GROUP SUBSCRIBERS SAVE UP TO \$1.50 Each

Form A Group Today!

You and your co-workers can now save up to half the regular cost of a RADIO subscription by using the Group Plan. The more men in a Group the more each saves, up to 50%.

Present subscriptions may be RENEWED or EXTENDED as part of a group.

The combination of exclusive, fine and timely articles plus this low-rate subscription offer makes RADIO a must-have publication. So fellows, form a Group today and send it to—



RADIO MAGAZINES, INC

342 MADISON AVENUE NEW YORK 17, N. Y.

TEAR OUT—MAIL TODAY!

RADIO MAGAZINES, INC.
342 Madison Ave., New York 17, N. Y.

Kindly enter the following subscription to RADIO Magazine. Remittance of \$..... is enclosed. (1 to 6 subscriptions may be ordered on this form).

- One 1-year subscription \$3.00
- Two 1-year subscriptions \$5.00
- Three 1-year subscriptions \$6.00
- Four 1-year subscriptions \$7.00
- Five 1-year subscriptions \$8.00

Groups of 6 or more subscriptions in the U.S.A. and Canada will be accepted at the rate of \$1.50 each. For Foreign groups add \$.50 to each subscription ordered.

PLEASE PRINT

Name

Address

Position Company

Name

Address

Position Company

Name

Address

Position Company

Name

Address

Position Company

Name

Address

Position Company

Name

Address

Position Company

Name

Address

Position Company

NOTE: If you do not wish to tear out this order blank, print or type a list giving each subscriber's name, address, employer's name and their respective positions. Mail it in today!

CUSTOM MADE

COAXIAL CABLE and TUBING

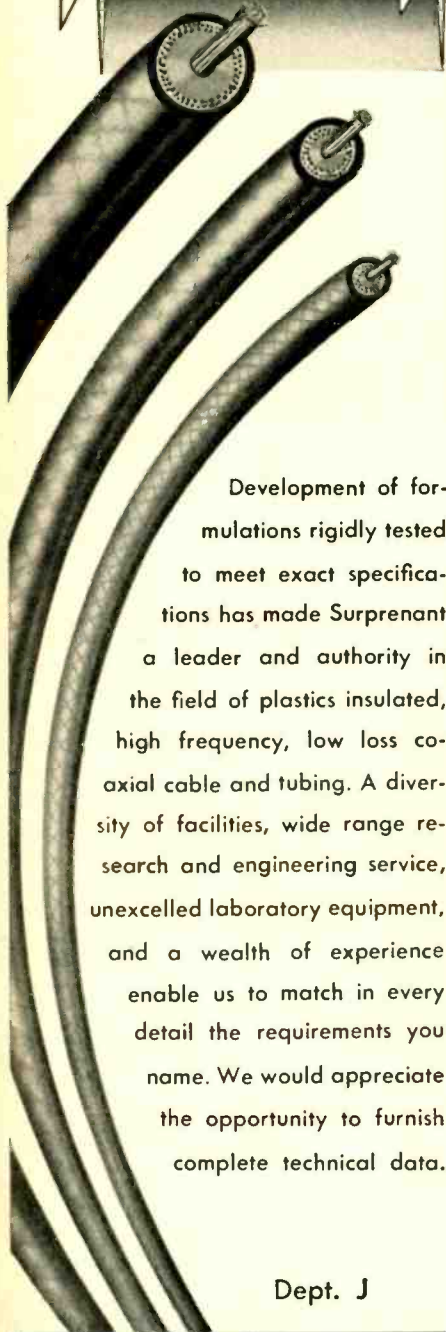

Development of formulations rigidly tested to meet exact specifications has made Surprenant a leader and authority in the field of plastics insulated, high frequency, low loss coaxial cable and tubing. A diversity of facilities, wide range research and engineering service, unexcelled laboratory equipment, and a wealth of experience enable us to match in every detail the requirements you name. We would appreciate the opportunity to furnish complete technical data.

Dept. J

Surprenant
ELECTRICAL INSULATION CO.

84 Purchase St.,

Boston 10, Mass.

emitting grid, which insure maximum tube life plus high efficiency.

The 3-150A is available in high mu (3-150A3) or low mu (3-150A2) versions, and includes a number of important engineering improvements. Data sheets are available upon request from Eitel-McCullough, Inc., San Mateo Ave., San Bruno, California.

DIRECT-COUPLED AMPLIFIER

This d-c coupled amplifier utilizes a new signal self-balancing and current drift-correcting direct-coupled output circuit. Response is 20 to 20,000 cycles ± 1 db. Develops 23 watts with less than 1% distortion. Less than $\frac{1}{2}$ of 1% is present at a 12 watt level. Overall gain: 96 db. Hum

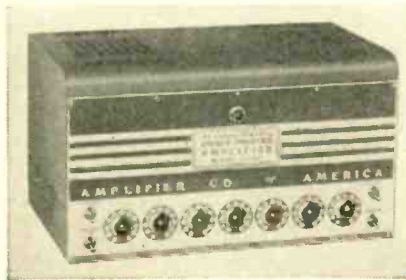

and noise level: —40 VU. Two independent inputs (each of 500,000 ohms) are provided. Balanced output terminals are provided for 4/8/16 and 500 ohms. In-between terminals provide the following additional output impedances: 1/2/6/10/12/83/100/125/150/166/175 ohms.

Furnished complete with input cables. Manufacturer, Amplifier Co. of America, 398 Broadway, New York 13, N. Y.

CAM-ROTOR CONDENSER

Timing Instrument Company has gone into production on an entirely new type of radio variable condenser, the "cam-rotor", which is claimed to have almost twice the electrical efficiency of condensers heretofore used.

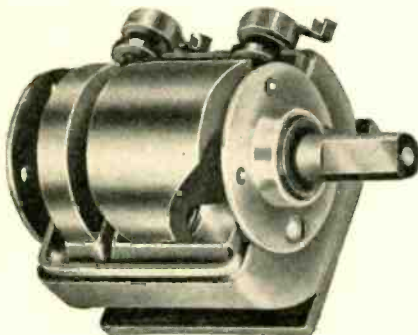

The condenser features solid-mass construction and fluid dielectric.

Full information on the cam-rotor variable fluid condenser may be obtained by addressing the sales offices of the Timing Instrument Company, 106 Spring Street, New York 12, N. Y.

SIGNAL GENERATOR

To be known as Simpson Model 415, this new signal generator is designed to be practically independent of line voltage fluctuation, with calibration stable regardless of wide variations in line voltage. Control of r-f output through its entire

Where nothing but the
BEST will do . . .



Hermetically
sealed
ELECTROLYTICS

● These Aerovox capacitors are positively sealed for longest trouble-free service. Once more available in the outstanding choice of types—ring-clamp mounting, insulated threaded stem (as shown, with grounded or insulated can), strap mounting, stud mounting, plug-in, drawn can or "bathtub", and low-cost midget "Dandees".

The Aerovox postwar catalog again lists the greatest selection of electrolytics ever offered.

• Ask for CATALOG . . .

Your jobber has a copy of the new Aerovox postwar catalog. Ask him for your copy. Or write us direct.



FOR RADIO-ELECTRONIC AND
INDUSTRIAL APPLICATIONS

AEROVOX CORP., NEW BEDFORD, MASS., U.S.A.
Export: 13 E. 40th St., New York 16, N.Y. • Cable: 'ARLAB'
In Canada: AEROVOX CANADA LTD., Hamilton, Ont.

MAY, 1946 ★

RADIO

range eliminates the necessity of a separate connection for high output. R-F out-

The 415 features modulation from 0 to 100% using either the 400 cycle internal



sine wave or an external source, high fidelity modulation up to 100% from below 60 cycles per second to over 10 kilocycles per second with no unwanted frequency modulation.

SENSITIVE RELAY

A sensitive, a-c or d-c, large load capacity relay, that will sell at a very low price, has been announced by Sigma Instruments, Inc., of Boston, Massachusetts.

Small size and weight are among the important features of the relay. The plug-in type weighs only 3 oz. and measures 1½" x 1½" x 1⅞". The unenclosed relay weighs 2 5/16 oz. and measures 1" x 1 7/32" x 2 3/16" long including mounting plate.

Other points are beryllium-copper armature and contact springs, spring reed-type armature hinge with low reluctance gap, and high permeability, low residual iron parts. Minimum input requirements are 20 milliwatts for d-c types and 0.1 volt amperes for a-c types. Contacts are s-p-d-t. and will handle, with somewhat more than marginal input power, up to 15 amperes on low voltage d.c. or 1 kw incandescent lamp load at 115 volts a.c.

FLEXIBLE WAVEGUIDES

Various types of flexible waveguides are being made by American Brass Company. They are made for operation at wavelengths from 20 to less than 3 cm. It is

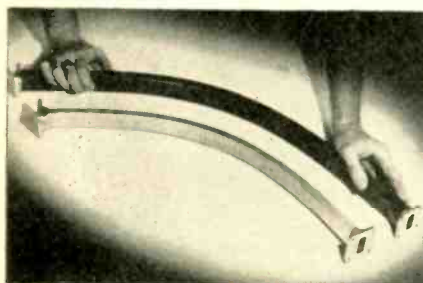

available in standard lengths mating with the common sizes of rigid guide. It can be bent in either of two planes and will withstand appreciable twist. Molded assemblies are pressure tight and quite rugged.

MOLDED COIL FORMS

Molded bakelite coil forms with anchored "hairpin" wire leads recently announced by the electronic components division of the Stackpole Carbon Co., St. Marys, Pa., provide a modern answer to the need for



NEW and Ready for you!

Allied's 1946 CATALOG

of Radio and Electronic Supplies

LARGEST AND MOST COMPLETE STOCKS... Under One Roof

You'll find this new Buying Guide extremely helpful and valuable today! Places over 10,000 items at your finger tips—for research, maintenance and production. Includes parts, tubes, tools, books, test instruments, public address and communications equipment. Concentrates all leading

makes here in one large central stock to give you faster, more efficient, more complete service—saves you time, work and money. Whatever you need... it pays to check with Allied. Write, wire or 'phone Haymarket 6800.



Everything in Radio and Electronics

ALLIED RADIO CORP.

833 W. Jackson Blvd., Dept. 14-E-6, Chicago 7, Illinois

FREE

Send for it

NOW

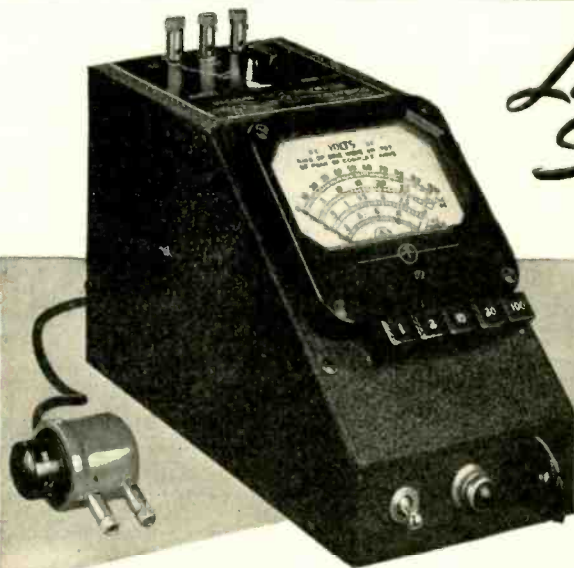

Laboratory Standards



MODEL 62

VACUUM TUBE VOLTMETER

SPECIFICATIONS:

RANGE: Push button selection of five ranges—1, 3, 10, 30 and 100 volts a. c. or d. c.

ACCURACY: 2% of full scale. Useable from 50 cycles to 150 megacycles.

INDICATION: Linear for d. c. and calibrated to indicate r.m.s. values of a sine-wave or 71% of the peak value of a complex wave on a. c.

POWER SUPPLY: 115 volts, 40-60 cycles—no batteries.

DIMENSIONS: 4¾" wide, 6" high, and 8½" deep. **WEIGHT:** Approximately 6 lbs.

PRICE: \$135.00 f.o.b. Boonton, N. J.

Immediate Delivery

MEASUREMENTS CORPORATION

BOONTON, NEW JERSEY

**IT'S NEW!
EXCLUSIVE!
READY NOW!**

**WRL GLOBE TROTTER
TRANSMITTER KIT**



25 Watt Output
**The Sensation
of the Year!**
\$59.95

Cat. No. 70-300

Complete including all parts, chassis panel, streamlined cabinet, less tubes, coils, and meter.

Cat. No. 70-312 Kit same as above, wired by our engineers \$75.00
Complete kit of 8 tubes Cat. No. 70-314..... \$5.95
3 in. meter Cat. No. 70-318..... 4.95
Coils, per set, any band Cat. No. 70-316..... 2.95
Crystals, 40-80 meters, mounted Cat. No. 70-322 ea..... 2.65
Quality crystal mike and stand Cat. No. 70-320. 9.45

Here is the latest, most outstanding transmitter value on the market today. The WRL Globe Trotter is capable of 25 Watts output on all bands from 3500 KC through 28 Mcacycles. Incorporates the Tritet Oscillator using a 40 metal X-tal and providing sufficient drive at 10 meters for the 807 final; Helmsing choke modulation; three bands, all pretuned; 10, 20, and 80 meters; metering provided for both oscillator and final stages; two power suppliers, one for 807 final and modulator tubes, one for speech amplifier and oscillator stage.

RECEIVERS



**Extra Special
NEW BC 348Q
SURPLUS
RECEIVERS**

Including Steel case, less speaker **\$85**
Cat. No. 35-61.....

Here is one of the hottest war-surplus receivers that will be available. 9 tubes, 2 IF stages, 3 stages of IF amplification. Frequency range, 200 to 500 kilocycles; 1 1/4 to 18 MC in four bands. Weather and aircraft bands, and all ham bands, except 10 meters.

Here are just a few of the many well-known receivers offered by Leo:

Hallcrafters S-38	39.50	Hallcrafters SX-25	94.50
Hallcrafters S40	79.50	Hallcrafters SX-28A	223.
RME 45	186.	Hallcrafters S41G	33.50
National NC 2-40C	225.	Hammarlund HQ-129X	129.

Trade-in plan and easy terms

SERVICE DEALER NEEDS



WRL MULTITESTER

Steel case with 30-50% angle **\$1875**
Cat. No. 16-491
Less Leads ..

Handles AC DC Voltmeter. DO Milliammeter, high and low range Ohmmeter. 3" meter with sturdy D'Aronsonal movement. Size 5 1/2 x 8 x 3 1/4.

A complete stock of tools, replacement parts, test equipment, intercom and public address systems . . . everything for the progressive service dealer.

FREE! OUR LATEST FLYER



Packed with real buys in radio, electronic, and general merchandise.

Giant Radio Map (size 3 1/2 ft. x 4 1/2 ft.) . . . 15c
Handy Tube-Base Calculator. . . 25c

Address: Dept. R-5
Council Bluffs, Iowa



Formerly Wholesale Radio Laboratories

inexpensive, easily-installed coil winding supports. Uses range from universal and taped universal windings to solenoid wind-

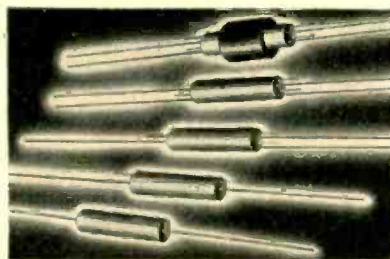

ings, antenna or coupled windings, iron-cored universal windings, iron-cored i-f transformer or coupled coils and various others.

TWO- AND THREE-POLE RELAYS

Kurman Electronics Corp., 35-18 37th Street, Long Island City 1, New York, announces a new line of two and three pole relays, series 16, featuring shockproof action under stress as high as ten times the force of gravity.

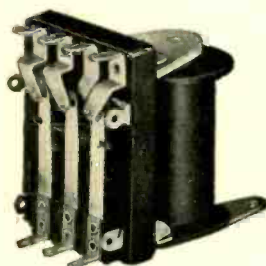

This relay is designed so that the activating armature is insulated from the contact arms by a bakelite link. This feature reduces chatter and provides a dielectric strength of 1500 volts between all contacts and ground.

Rated for 2 watt operation, the coil will dissipate as much as 4 watts in continuous operation without overheating. Any two or three pole contact combination is available. The contacts are rated to carry 2 amperes at 100 watts.

NEW PM MATERIALS

Five new permanent-magnet materials, known as cunico, cunife, vectolite, alnico 12 and silmanal, have been announced by the General Electric Company. These new materials have many applications in the

manufacture of aircraft instruments, as well as other industrial uses where small,

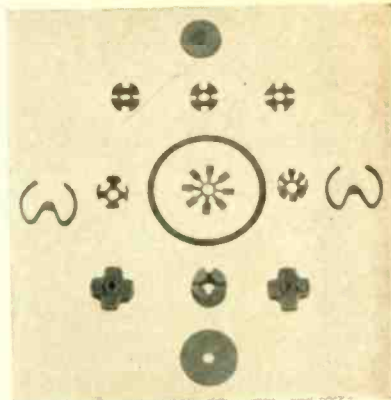

lightweight magnets formed in intricate shapes are required.

FREQUENCY METER

Browning Laboratories, Winchester, Mass., has developed a new frequency meter (Model S-4) to cover specified frequencies in the range from 1.5 to 100 mc. This meter may be employed for checking the frequency of either AM or FM transmitters to an accuracy of .0025%. A 100-kc crystal is used as a secondary stand-

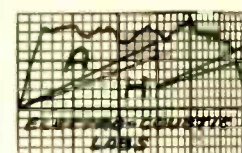

For
Repair
Calibration
of
Microphones
Pick-ups.

A - H

ELECTRO-COUSTIC LABS
P. O. BOX 5201—E. MICHIGAN ST. STATION
INDIANAPOLIS
CUSTOM BUILDING
A
SPECIALTY

Ted McElroy
World's Largest Manufacturer of
Wireless Telegraphic Apparatus
COMPLETE CENTRAL OFFICE EQUIPMENT
McElroy Manufacturing Corp.
82 Brookline Avenue • Boston, Massachusetts

SWEDEN

Well established and highly reputable firm of importers, with large sales staff, desires contact with manufacturers and suppliers of:

- Portable battery radio receivers
- Batteries for such sets
- Radio tubes of all types for receivers
- Electrolytic condensers, rheostats, replacement parts
- Record-changers, mikes and pickups
- Novelty items and radio accessories
- Bakelite and other plastics

We want to import on firm account with sole selling rights for Scandinavia.

(References: Swedish Legation, Com'l Dep't., Washington; Skandinaviska Banken, Svenska Handelsbanken, Södertälje, Sweden)

HARRY ANDERSON — Södertälje — SWEDEN

HOUSINGS AND STAMPINGS

Stamford Metal Specialty Co., 427-29 West Broadway, New York 12, N. Y. announces the availability of a new line of panels, chassis and housings for instruments, meters, test equipment, radio, radar and electrical appliances.

A complete integrated service is offered, including tool and die-making, engraving, etching, spot welding, arc and gas welding, as well as the final assembly of the equipment required.

BOOK REVIEWS

Applied Mathematics for Radio and Communication Engineers, by Carl E. Smith, published by McGraw-Hill Book Co., Inc., New York, 336 pages, illustrated, cloth binding, \$3.50.

This book is intended for self-study and reference, and has been preceded by four private editions used in a practical home-study course. A background of prep school mathematics, and some familiarity with radio terminology is assumed.

The author has done a thorough job, and presents his material in a clear and understandable manner. Starting with algebra, the book proceeds through vectors, complex quantities, hyperbolic trigonometry, differential and integral calculus, and series. Wave forms are given particular attention.

A good appendix presents the Greek alphabet, mathematical and engineering symbols, conversion tables, Bessel functions, factorials and their reciprocals, and sine-cosine integrals, in addition to trigonometric and logarithmic tables.

Numerous problems are given for self-examination, with answers. The book is provided with a comprehensive index.

Understanding Microwaves, by Victor J. Young, published by John F. Rider Publisher, 404 4th Ave., New York City, 400 pages, cloth binding, \$6.00.

This book explains the fundamental problems encountered in the field of ultra-high frequency research and production, and how they are surmounted; problems met in the design and operation and waveguides and coaxial lines; resonant cavities as they function in the magnetron, the dynatron, and the klystron; the theory and design of antennas used in conjunction with the transmission and reception of microwaves.

The theories upon which this technique is built: electromagnetic and electrostatic fields, microwave generation, radiation and reflections are interpreted in the early chapters.

A comprehensive collection of terms, ideas, and theorems, explaining their nature and use in radar and microwave communications is contained in section II. This is included for ready reference

talk about **SERVICE!**

The VALPEY CRYSTAL CO
Holliston, Mass

March 4, 1946

Gentlemen:

In the cloth bag attached to this envelope, I am returning to you one of your type VP-3 crystals, frequency 14324 kc. If it is at all possible, could you please grind this crystal down to a frequency of 14,515 25 kc. This is probably a most unusual request, but this particular crystal is such an excellent piece of quartz and oscillates so satisfactorily that I would like to convert it to a frequency good only for the high end of the amateur 10 meter band. If you can do this for me, kindly do so, and return the crystal C. O. D. for labor charges, etc. It is not necessary, as far as I am concerned, that you supply a new name plate cover with the new frequency on it, unless you have definite policy in this regard.

Incidentally, my experience with Valpey crystals has been excellent. As I recall, The Radio Shack in Boston sold me my first Valpey crystal back around 1933 or 1934. My first 20 meter crystal was a Valpey — in a generous octagon case, black, and with an aluminum top cover. It still oscillates today, but as a result of numerous cleanings has lost some of its old time snap. I also have numerous 40 meter Valpey crystals which date back at least 11 years, to the best of my memory, which are still functioning perfectly even though they were used with 47 oscillators and were heavily overloaded.

This is quite a ramble, but Valpey gave the amateur low-priced crystal control, and reliable crystal control, for which I am certain many amateurs are, and always will be, grateful and appreciative.

W1GCU/W1

Yours sincerely,

George E. Donahue

**THIS is but one of many
ENDORSEMENTS of
VALPEY CRYSTALS**

ANOTHER PUBLICATION
BY THE
EDITORS OF
RADIO

CQ

The Radio Amateurs' Journal

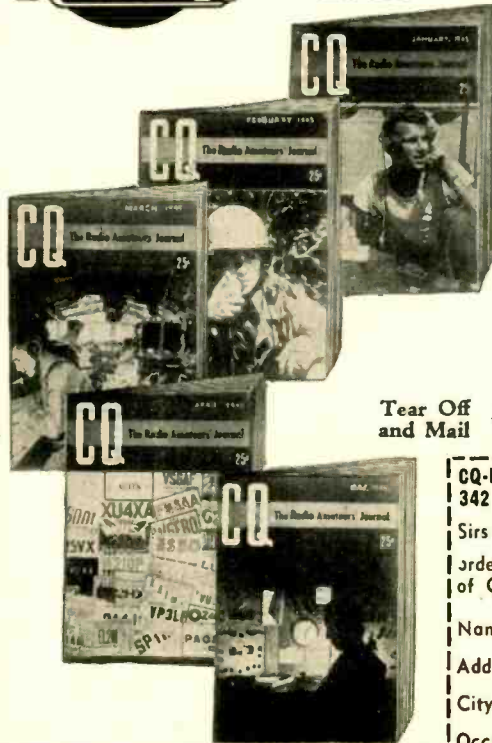

If you are or intend to be a "ham" — or if your work entails radio communications — you'll like CQ. Subscribe now!

12 issues \$2.50
24 issues 4.00
36 issues 5.00

In U.S.A. & Possessions
Elsewhere \$3.50 per year

Tear Off
and Mail ↓

"CQ" is sold on newsstands

CQ-RADIO MAGAZINES, INC.
342 MADISON AVE., NEW YORK 17, N. Y.

Sirs: Here is my check (or money order) for \$..... Send me issues of CQ.

Name
Address
City State
Occupation Call Letters.....

LOOK!



BEAM POWER TUBES



829-B push-pull R-F beam power amplifiers. Exceptionally efficient, with full input at frequencies up to 200 Mc. Max. ratings are: 750 plate volts, 49 watts plate dissipation. While they last...
\$4.95
 Stock Number # PS116

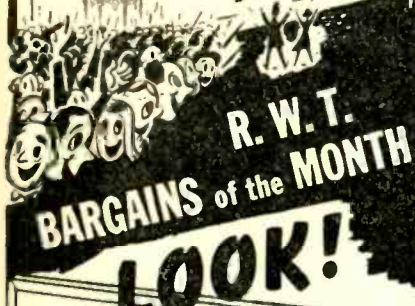

R. W. T. BARGAINS of the MONTH

LOOK!

ACORN TUBES

Government Released, Sensational offer. Normally \$2.85-\$5! Stock No. WPS 422: Type 954. Stock No. WPS 423: Type 955. Stock No. WPS 424: Type 956. Stock No. WPS 425: Type 957. Socket for above. #W846, price 49c



69c



FREE! Latest Bargain Flyer includes test instruments, record changers, communication receivers, ham transmitting tubes and many other electronic items you need today. Big new catalog coming! Get your name on our list!

Radio Wire

Television Inc.

NEW YORK 13 BOSTON 10 NEWARK 2

Originators and Marketers of the Famous

Lafayette Radio

Cut out coupon, paste on penny post card, mail today.

R. W. T. Dept. BE6

100 AVENUE OF THE AMERICAS, NEW YORK 13

Gentlemen: Send me FREE copy of your Latest Bargain Flyer and put my name on list for your Big New Catalog

NAME _____

ADDRESS _____

CITY _____ ZONE _____ STATE _____

and will prove invaluable to engineers, research workers, students, and those interested in the development of microwave technique.

A special feature is the pair of frequency spectrum charts found on the jacket of the book.

During the past decade, research in the microwave region of the electromagnetic spectrum has given scientists a new tool; by its means the presence of objects scores of miles distant can be detected on the darkest night; ships can be guided into fogbound harbors; a dozen or more conversations can be conducted over one telephone circuit, and there are other applications too numerous to mention. But it is not with these results that this book deals; instead it discusses the underlying principles upon which they are based.

The principles upon which any science is based must be understood if apparatus embodying the principles is to be used intelligently. This is particularly true with microwave equipment, for there is a tremendous stride from the solid connectors of a broadcast transmitter to the waveguide of a radar set; from the triode oscillator to the magnetron; from the wires of the long-wave transmitting antenna to the pocket-sized dipole and its reflector. These are new components with which the student of modern radio must be familiar, for there is no doubt that radio technique of tomorrow will be with waves measured in centimeters and millimeters.

TECHNICANA

[from page 10]

compact, portable or lightweight has been announced by Sylvania Electric Products Inc., radio tube division, 500 Fifth Avenue, New York 18, N.Y. The tube may be operated in any position and is not affected by ambient temperature.

Typical ratings and characteristics of the type 6D4 miniature thyratron are as follows:

Heater voltage, a-c	6.3 volts
or d-c	
Heater current	250 milliamperes
Maximum voltage between elements	450 volts
Heating time	30 seconds
Maximum peak anode current	100 milliamperes
Maximum heater-cathode voltage	—199 volts ± 25 volts

ERRATUM

We are informed by the editors of *Electronic Engineering* that the Hi-Fi Bass compensating circuit which appeared in their February 1946 issue, and which was reported in the *Technicana* column of RADIO for March, was not quite correct. The secondary of the input transformer should be connected to ground instead of to the top of L1.

there is
NO SUBSTITUTE

for GOOD communications and industrial wire. We are shipping you more and more of it now . . .



WIRES



cornish

WIRE COMPANY, INC.



15 Park Row, New York 7, N. Y.

"Made by Engineers for Engineers"

NOW...IN 3 EASY STEPS, MAKE PHOTOCOPIES of Anything! Right in your office!

1. INSERT
Anything you want copied — with a piece of APÉCO paper —

2. PRESS THE SWITCH

3. PROCESS
No darkroom or technical knowledge needed.

Photo Copier \$55
Copies up to 18" x 22"

Also continuous cabinet models for prints of any length, up to 42 in. wide

Amazing new unit The APÉCO PHOTOEXACT
Copies Anything!
AMERICA'S MOST WIDELY USED PHOTOCOPY EQUIPMENT

And you have your low-cost copies of: LETTERS, BLUE PRINTS, CLIPPINGS, PICTURES, CONTRACTS, FINANCIAL DATA, VALUABLE PAPERS, CHARTS or over 100 others

Make error-proof, permanent copies, at 1-a-minute speed—of anything written, typed, printed, drawn or photographed—even if on both sides! APÉCO saves time, labor, money—any boy or girl can operate it.

Get this helpful FREE book MAIL COUPON NOW

AMERICAN PHOTOCOPY EQUIPMENT CO.
2849 N. Clark St., Dept. RA56 Chicago 14, Ill.

Please send me, without obligation, your free 20-page illustrated book on Photocopying.

NAME _____
 COMPANY _____
 TITLE _____
 ADDRESS _____
 CITY & STATE _____

AUTHORS ATTENTION!!

WE are interested in considering for publication manuscripts covering any phase of radio or the electronic art at a fundamental or advanced level. If you have a manuscript, send it to us or if you have an idea for a manuscript, submit a synopsis of the material, an estimate of its length, number of illustrations, etc. In either case, it will be given prompt editorial consideration. Advance against royalties can be arranged.

JOHN F. RIDER PUBLISHER, INC.
Editorial Dept.
404 FOURTH AVENUE
NEW YORK 16, N. Y.

18 YEARS IN RADIO

Get This *New* Catalog
By This *Old* Firm

Latest developments in radio and electronic parts and devices, newest ham gear, gadgets to delight the heart of the experimenter, bargains in war surplus supplies.



- Buy from B-A
- Save Time
- Save Money
- Get the Newest
- Deal with This Old House



It's
FREE
To You

MAIL COUPON TODAY

Don't delay, get your copy of this book.

BURSTEIN-APPLEBEE CO.,
1012 McGee, Kansas City 6, Mo.

Send me FREE new catalog. RADIO

; AM _____
STATE CONNECTION IN INDUSTRY

NAME _____

ADDRESS _____

TOWN _____ STATE _____

RADIOLOCATION

[from page 28]

Precision Radar

W. A. S. Butement—B. Newman—A. J. Oxford

A historical review of the project of locating single large objects in free space using ultra-short waves and working from a single station. Using the new modified propagation laws the accuracy at 20 miles is ± 25 yards. One mile is approximately 10 microseconds and 100 yards is approximately 0.6 microsecond.

Velocity Modulation Valves

Dr. L. F. Broadway

While the velocity modulation valves of the klystron type, which is basically a controllable cw oscillator, has not proved as efficient as the magnetron, it must be realized that considerable theoretical work remains unfinished in the production and interaction of electron beams.

The Crystal Valve

B. Bleaney

No. r.f. stage or valve type mixer has proved as efficient as the crystal. A combination of tungsten or molybdenum whiskers and silicon as the semi-conductor has been the most successful.

Cathode-Ray Tubes for Radar

G. S. J. Gorlisk—S. T. Henderson—P. Puleston

The most important factor in cathode-ray tube design is the ability of the tube to retain a sharp plan between successive sweeps of the beam. The tube used in the H₂S bombing radar has been a special adaptation of the intensify-modulated variety. However, even this tube after 600 sweeps leads to a complicated screen excitation condition that is still unsolved.

Visibility of Cathode-Ray Tube Tube Traces

R. C. Hopkinson

If the radar operator is to examine the cathode-ray tube plan effectively it will be related to the following conditions: The illumination in the operator's background and the brilliance of the trace, a visual-persistence law and a visual sensation stimulus ratio. Many of these problems have been solved by the use of new type screens, while others have been remedied by mechanical shields, etc.

The Skiatron, or Dark Trace Tube

P. G. R. King

The skiatron is a fairly recent development incorporating a standard type of magnetic focusing which deflects the cathode ray beam upon a special screen. This display appears as a dark line on a white background, similar to a pencil sketch. It is necessary that considerably more work be expended on this type of tube since the decay characteristics are not good enough to warrant general use.

Cathode-Ray Tube Problems

J. G. Barlett — D. S. Watson — G. Bradfield

This was a joint paper. The most recent development in cathode-ray tube applications has been the elimination of the bulky high voltage power supply. This has been replaced by the very compact vibrator-

TO INSURE A
BIG JOB IN A
LITTLE SPACE

SPECIFY
Hi-Q
COMPONENTS

DUREZ
COATED
CAPACITORS



STAND-OFF CONDENSERS



CERAMIC
CAPACITORS



WIRE WOUND
RESISTORS



CHOKE COILS

**ELECTRICAL REACTANCE
CORPORATION**
FRANKLINVILLE, N. Y.

New!
Complete!
RADIO
CATALOG
Free!



Mail
Coupon for
FREE
Copy!

- RADIO SETS**
- AMPLIFIERS**
- RADIO PARTS**
- ELECTRONIC EQUIPMENT**

Your copy of the complete, new Concord Catalog is ready! It offers you the greatest selection of guaranteed quality RADIO SETS, PHONO-RADIOS, RADIO PARTS, TEST INSTRUMENTS, BOOKS, TOOLS, AMPLIFIERS AND ACCESSORIES, AMATEUR KITS AND SUPPLIES . . . page after page of post-war-engineered equipment and parts you have long been waiting for. All standard, top-quality lines. Thousands of items. Money-saving prices. See the thrilling MULTIAMP Add-A-Unit Amplifiers, brand new in the field, with sensational new flexibility, fidelity and power—EXCLUSIVE with CONCORD. Your copy is ready . . . and it's FREE. Rush this coupon today.

CONCORD
RADIO CORPORATION
LAFAYETTE RADIO CORPORATION
CHICAGO 7 ★ ATLANTA 3
90 P.W. JACKSON BLVD. 265 PEACHTREE ST.

Concord Radio Corporation, Dept. F-56
901 W. Jackson Blvd., Chicago 7, Ill.

Yes, rush FREE COPY of the comprehensive new Concord Radio Catalog.

Name.....
Address.....
City..... State.....

operated supply and in others by the selenium rectifier piles. Although many other devices have been tried, the cathode-ray tube has been the most successful in displaying the exact position of a non-cooperating target area. At present the services are employing two main types of cathode-ray tubes, the intensity modulated and the deflection modulated.

Gas-Discharge Switches
A. H. Cooke

Strictly a war-time necessity, the T-R cell consists of a glass enclosed cavity resonator filled with an inert gas at a low pressure. By correctly coupling across the receiver antenna input terminals, the T-R cell will short during the transmitted pulse and protect the receiver.

Triodes for UHF
J. Bell

A discussion of the merits of the disk-seal tube. Some have their elements in a planar array, others in a cylindrical fashion.

Vapor Thyratrons
H. deB. Knight

Since high voltage pulses are required of an order of a few microseconds, there is a period where the positive ions return to the cathode under very high energies. This bombardment may be reduced by better geometrical design of the arc path and utilizing the correct operating temperature.

Monitors at Centimeter Waves
L. B. Turner

A description of the methods of measuring the variations in total power output and discovering the reflections in transmission lines due to mismatching.

The Enthrakometer
J. Collard

In the field of microwave power measurement, the gold leaf electroscopes and the enthrakometer have been very successful in these applications since their error is less than 5%.

Measurement of Cables
Dr. I. Essen

Where radar locations require the various units to be separated by some hundred feet or more, polythene cables have been employed almost universally. All cables must be maintained to very close tolerances.

Automatic Contour Plotter
J. Dyson — B. A. C. Tucker

A special mechanical system of photo-electric cells operating from the output of valve and crystal detector and amplifier, which prints upon a graph paper a contour of field strength over a background of cartesian co-ordinates representing the altitude and azimuth from the radar antenna.

Shipboard Radar
A. W. Ross

The problem of a shipboard radar is the effective operation of 30 or more units simultaneously. Interference with the radio telephone services is particularly important as is the life of the microwave crystal in the strong r-f fields.

ADVERTISING INDEX

ADVERTISER	PAGE
Adams & Westlake Co.	9
Aerovox Corporation	42
A-H Electro-Coustic Labs	44
Allied Radio Corp.	43
American Phenolic Corp.	Cover 2
American Photocopy Equipment Co.	46
Anderson, Harry	44
Bell Telephone Labs	33
Bliley Electric Company.	Cover 4
Burstein-Applebee	47
Capitol Radio Engineering Inst.	8
Concord Radio Corp.	48
Cook Electric Company	29
Cornish Wire Co., Inc.	46
Eitel-McCullough, Inc.	11
Electrical Reactance Corp.	47
Federal Tel. & Radio Corp.	2, 3
Galvin Mfg. Corp.	7
Heintz & Kaufman, Ltd.	39
Insulation Manufacturers Corp.	12
Insuline Corporation of America	10
Jensen Radio Manufacturing Co.	31
Kaar Engineering Co.	25
McElroy Mfg. Co.	44
Measurements Corp.	43
Ohmite Manufacturing Co.	27
Racon Electric Company, Inc.	37
Radio Wire Television, Inc.	46
Rider, John F. Publisher, Inc.	47
Simpson Electric Co.	5
Sperry Gyroscope Co., Inc.	Cover 3
Sprague Electric Co.	35
Surprenant Elec. Insulation Co.	42
Tech Laboratories	40
Triplett Elec. Instrument Co.	40
Valpey Crystal Corp.	45
World Radio Laboratories	44
Wrigley, Wm. Jr. Co.	38

LORAN BY SPERRY

03617
TIME DIFFERENCE

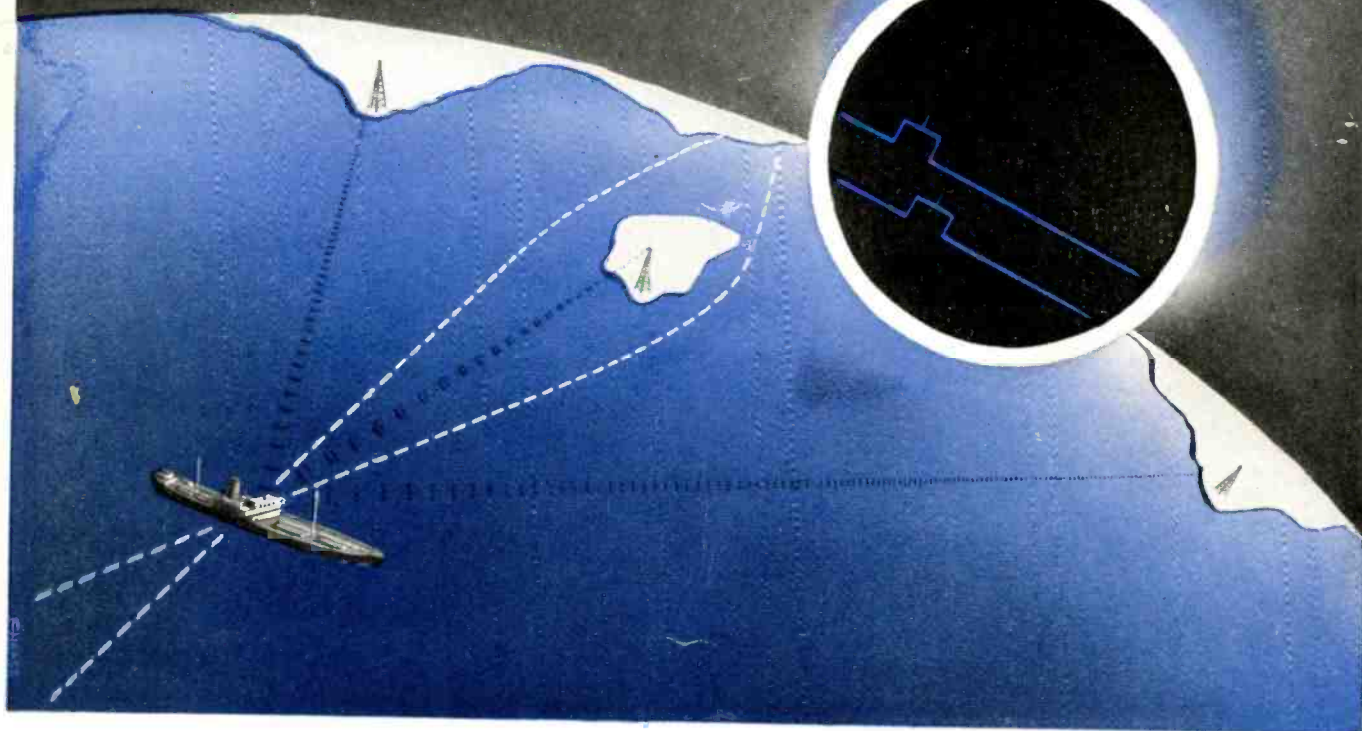

Accurate **LO**ng **RA**nge **N**avigation...anytime...in all weather

With Sperry Loran the navigator has at hand a quick and accurate means of determining a ship's position at any time, in all kinds of weather. This system involves the reception of accurately timed radio pulses from shore-based transmitting stations, usually 200 to 400 miles apart.

The difference in time of arrival of signals from a pair of transmitting stations is measured and the time difference is then used to determine, from special charts or tables, a line-of-position on the earth's surface. When two lines-of-position from two different pairs of Loran stations are

crossed, you have a "Loran fix." Fixes are obtainable at distances from shore stations up to 1400 miles at night, 700 miles in daytime.

In your consideration of Loran, note particularly that Sperry's equipment is easy to operate. A Time Difference Meter (see illustration above) greatly simplifies the operator's

work and prevents errors in readings.

Sperry Loran is backed by a worldwide service organization and meets the usual high standards of test and performance of all Sperry products. *Loran equipments in limited quantity are ready for immediate delivery.*

**The Time Difference Meter, giving position references directly, is a Sperry exclusive.*



Sperry Gyroscope Company, Inc.

EXECUTIVE OFFICES: GREAT NECK, NEW YORK • DIVISION OF THE SPERRY CORPORATION
LOS ANGELES • SAN FRANCISCO • NEW ORLEANS • HONOLULU • CLEVELAND • SEATTLE
GYROSCOPICS • ELECTRONICS • RADAR • AUTOMATIC COMPUTATION • SERVO-MECHANISMS



Techniquality

Every product that enjoys the full confidence of those who use it has its "priceless ingredient." In Bliley crystals it's "techniquality."

Cutting, grinding, and finishing alone do not transform raw quartz into a sensitive frequency control device. Behind these operations there must be a background of technical skill and creative engineering that is gained only through years of experience.

Bliley crystals have a reputation for "techniquality" that started fifteen years ago. Today, the fact that Bliley crystals are used in practically every phase of radio communications is tacit proof that leading engineers have found it is best to specify Bliley "techniquality" crystals.

Bulletin 27 describes the crystal units engineered for the needs of today. Write for your copy.



Bliley
CRYSTALS

BLILEY ELECTRIC COMPANY • UNION STATION BUILDING, ERIE, PENNSYLVANIA